

The pure wellbeing  
experience

*Perfect Wellne\$*

**effegibi®**



For over 25 years,  
Effegibi has been  
designing and  
manufacturing saunas  
and Turkish baths  
with state-of-the-art  
technology

Da oltre 25 anni  
Effegibi  
progetta e produce  
saune e bagni turchi  
con tecnologie  
all'avanguardia

Effegibi is central to a story that starts with tradition and stretches right into the most innovative future. This is a story of wellbeing, of the ancient traditions of the sauna and the Turkish bath that today's advanced technology and design excellence have clothed in a new guise. This evolution has been made possible by our company that, since 1987, has focused entirely on this sector and we are proud to offer saunas and Turkish baths that are 100% Italian, from design to manufacture.

This philosophy has enabled Effegibi to become the well-deserved leader in our field, winning the trust of our customers the world over. One of our strong points is the excellence of our high-tech solutions, always in the vanguard of progress with long-lasting, energy-saving products of certified quality, requiring very little maintenance.

In addition to our constant quest for high performance and practicality, we at Effegibi are fully aware that feeling good equates to looking good and so we take just as much care over aesthetics. Our saunas and Turkish baths feature clean lines traced by such famous designers, often with generous expanses of glass that transform them into stylish items of furniture. We use only eco-friendly materials, with no plastic and the wood is always top quality from reliable sources that do not cause deforestation or endanger rare trees under threat. Effegibi's extraordinary know-how translates into precise made-to-measure solutions.

Effegibi è al centro di una storia che parte dalla tradizione e arriva nel futuro più innovativo. La storia è quella del benessere, di antichi riti come la sauna e il bagno turco che oggi assumono una veste contemporanea grazie a tecnologie avanzate e raffinato design. Dietro a questa evoluzione c'è un'azienda che dal 1987 ha dedicato la sua attività unicamente a questo settore, orgogliosa di offrire una produzione di bagni turchi e saune interamente italiana, dalla progettazione alla produzione.

Con questa filosofia Effegibi è divenuta meritatamente leader nel suo campo, conquistando la fiducia di clienti in tutto il mondo. Un punto di forza è dato dall'eccellenza delle soluzioni tecnologiche, sempre all'avanguardia che garantiscono prodotti di qualità certificata, di lunga durata, con manutenzione ridottissima e risparmio energetico.

Oltre a ricercare elevate prestazioni e funzionalità, Effegibi sa bene che benessere fa rima con "bell'essere", e quindi pone uguale attenzione anche all'estetica. Saune e bagni turchi sono disegnati con linee pulite, tracciate da illustri designer, spesso con grandi aperture vetrate che le trasformano in eleganti oggetti di arredamento. I materiali sono ecocompatibili, non viene utilizzata plastica, i tipi di legno sono di prima scelta e non provengono da deforestazione o da alberi in estinzione. Lo straordinario know-how di Effegibi si traduce in accurate soluzioni su misura.

All Effegibi products are subject to quality checks in terms of both their aesthetics and functions. The safety of Effegibi products is certified by all the leading international certification bodies to guarantee compliance with the most rigorous current standards.

Ogni articolo Effegibi è sottoposto a verifiche qualitative sia sotto l'aspetto estetico che funzionale. La sicurezza dei prodotti Effegibi è certificata a livello internazionale dai principali marchi di qualità che garantiscono il rispetto delle più severe normative vigenti.





## Finnish sauna

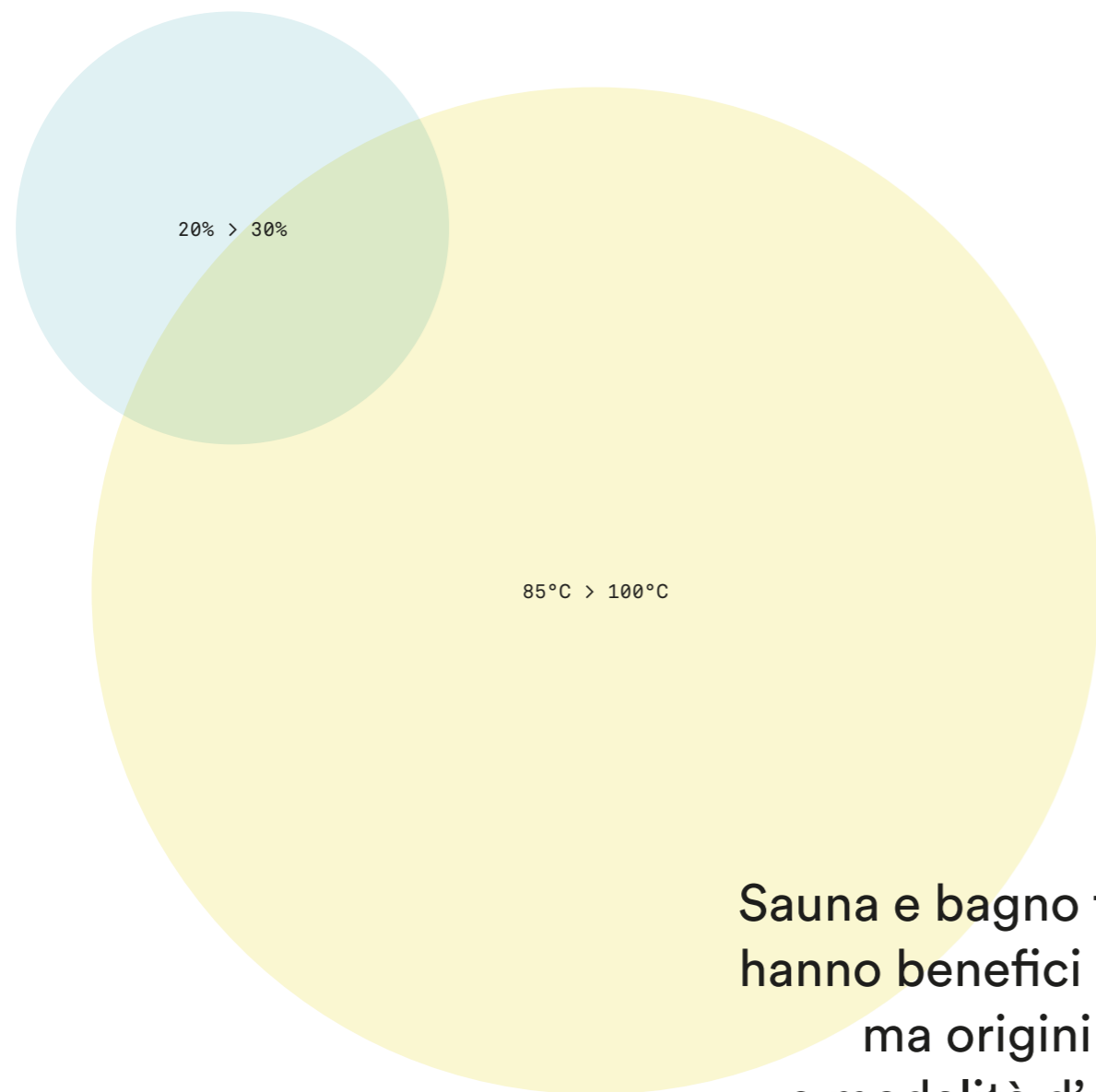

Sauna e bagno turco hanno benefici simili ma origini e modalità d'uso diverse

## Turkish bath

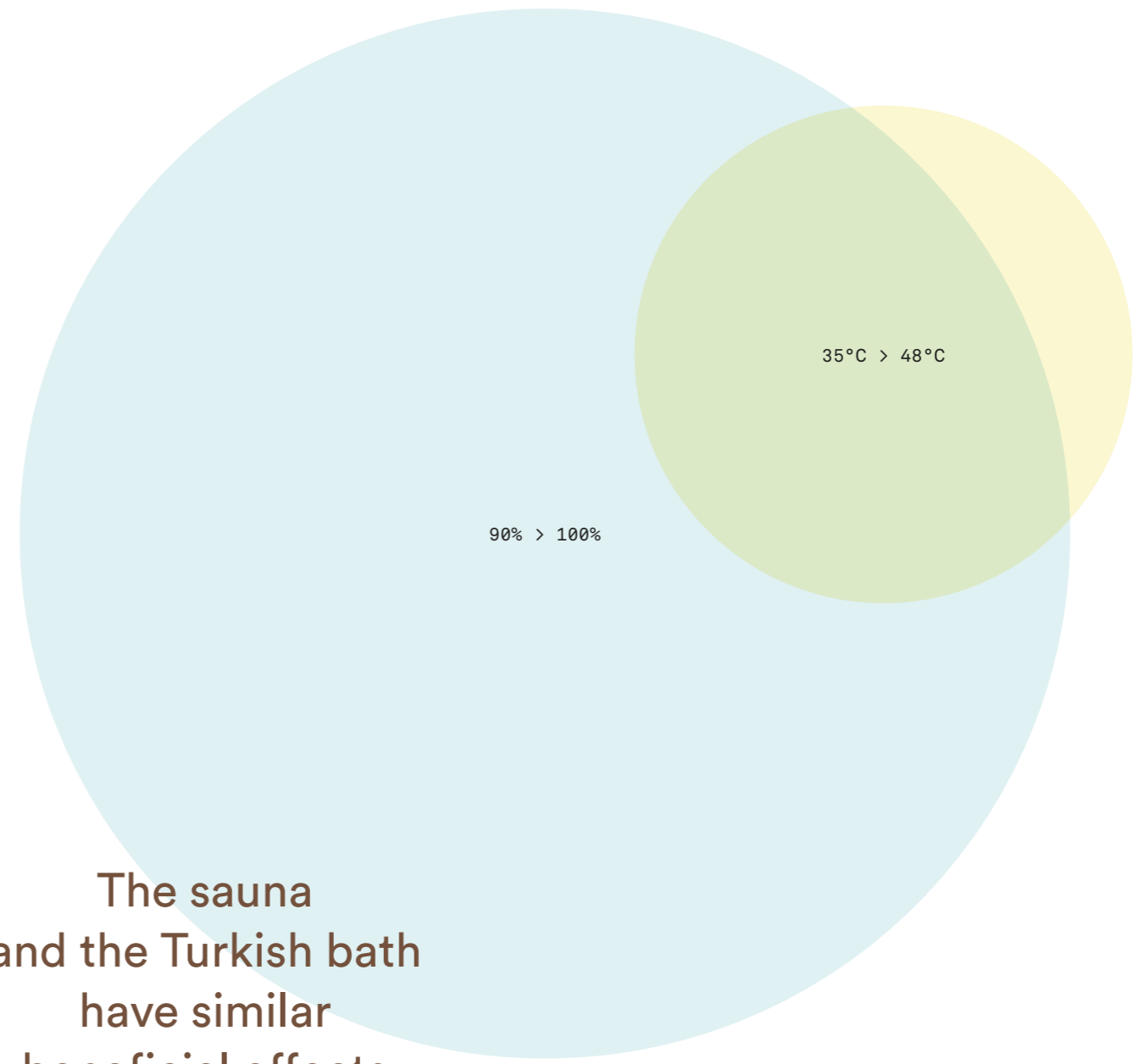

The sauna and the Turkish bath have similar beneficial effects but their origins and the way they are used are different

## The Finnish sauna

From its Scandinavian beginnings it has conquered the whole world.

The heat in a sauna can reach temperatures up to 100°C but the low humidity (20-30%) transforms this into a pleasant embrace that relaxes the muscles and stimulates bodily purification.

The wood exudes the perfumes of nature, issuing a primitive call to rediscover your inner calm, freeing the mind of all stress.

*First build your sauna  
and then build your house.*

This old Finnish saying tells how a simple bath of warm, dry air can become the beating heart of your daily wellbeing.

### Sauna finlandese

Un rito che dal Nord Europa si è diffuso in tutto il mondo.

Nella sauna il calore può raggiungere temperature fino ai 100°C, ma grazie alla bassa umidità (20-30%) si trasforma in un piacevole abbraccio che rilassa la muscolatura e favorisce la depurazione dell'organismo. Dal legno si sprigiona il profumo della natura, un primitivo invito a ritrovare la serenità della mente liberando tutte le tensioni.

*Prima costruisci la tua sauna,  
in seguito la tua casa.*

Questo antico detto finlandese racconta come un semplice bagno di aria calda e secca possa divenire il centro vitale del proprio benessere quotidiano.

## The Turkish bath

Water equals health, including when it is in the form of a cloud of steam enveloping the body. In far off days this secret was discovered by the Ancient Greeks, Romans and all those Middle Eastern peoples who made the Turkish bath a philosophy of life. In contrast to the sauna, the humidity reaches 100% and the temperature never exceeds 48°C.

Seated on marble or natural stone, enveloped in an impalpable mist, you inhale the warm steam, decongesting the lungs and your sweat carries away all toxins as you distance yourself from the surrounding space, becoming aware of only the feelings of your own body.

### Bagno turco

L'acqua è salute, anche quando assume la forma di una nuvola di vapore che avvolge il corpo.

L'hanno scoperto in tempi lontani i greci, i romani, i popoli mediorientali che hanno fatto del bagno turco una filosofia di vita. Al contrario della sauna, l'umidità raggiunge il 100% e le temperature non superano i 48 °C. Seduti sul marmo o sulla pietra, avvolti da una nebbia impalpabile, s'inala il tiepido vapore che decongestiona il respiro, ci si libera attraverso il sudore di ogni tossina, ci si estranea dallo spazio circostante e si avverte soltanto la percezione del proprio corpo.

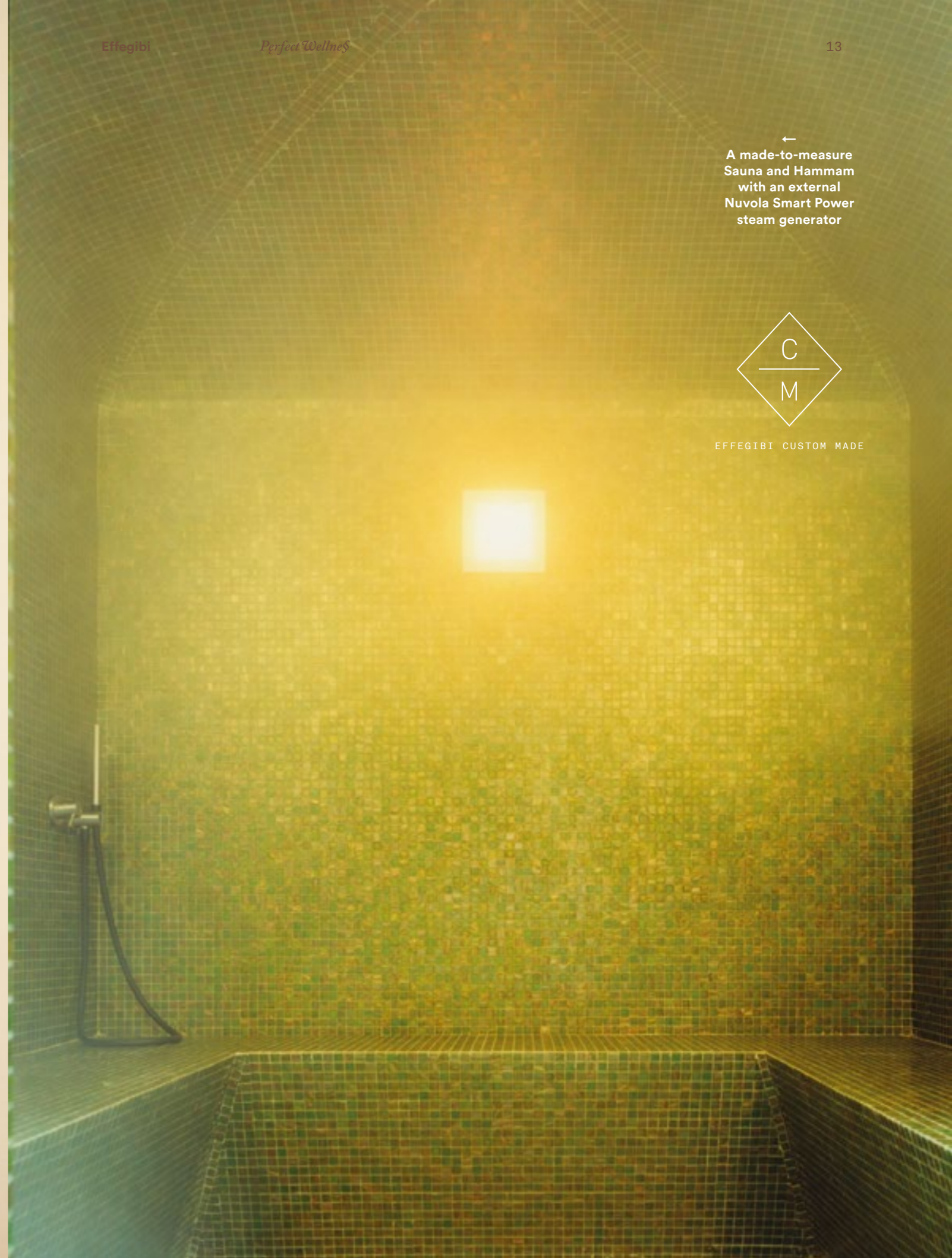

←  
A made-to-measure  
Sauna and Hammam  
with an external  
Nuvola Smart Power  
steam generator



EFFEGIBI CUSTOM MADE



EFFEGIBI CUSTOM MADE

Saune, hammam e sistemi Effegibi possono essere adattati a qualunque spazio: realizza il tuo personale centro benessere, progettato su misura per sfruttare al meglio ogni ambiente disponibile.

Effegibi saunas, Hammams and complete systems can be adapted to fit any space. Create your very own personal spa, tailor-made to make the very best use of any available environment.



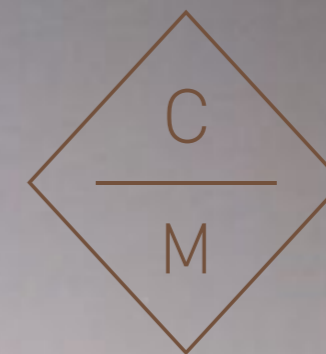

EFFEGIBI CUSTOM MADE

**Personalizza  
la tua sauna con un legno  
dal sapore speciale:  
finiture uniche e rare,  
che portano  
il segno della storia**

**Personalise your sauna  
with a very special  
type of wood,  
unique stylish finishes  
that bear the hallmark  
of history.**





→ The Effegibi  
in-house technology R&D  
and production departments  
guarantee a highly  
professional personalised  
service



→ Version:  
BodyLove H.  
Finishes: grès porcelain  
Auvergne.  
Wall-fitted bench in Corian®  
with teak accessories.

# BodyLove

SAUNA + HAMMAM  
Design: Rodolfo Dordoni  
with Michele Angelini

**Sistema modulare  
che unisce sauna,  
bagno turco, doccia:  
una vera Spa personale,  
progettata  
per essere versatile  
ed elegante**



The modular system  
combining sauna,  
Turkish bath  
and shower.  
A real personal spa  
designed for versatility  
and style.

→ Sistema modulare integrato con sauna, bagno turco e doccia  
 → Modular system combining sauna, Turkish Bath and shower

→ Ampia possibilità di composizione degli ambienti Sauna e Hammam per soluzioni personalizzate con l'area benessere  
 → Multiple combining options for Sauna and Turkish Bath unit for individual solutions within the wellness area

→ Sauna disponibile nelle finiture hemlock canadese e legno massiccio termotrattato  
 → Sauna wood finish available in Canadian Hemlock and heat-treated hardwood

→ Componenti hammam di eccezionale qualità: gres porcellanato Champagne o Auvergne oppure vetro a canne, panche bianche in Corian®, accessori in Teck  
 → Turkish bath materials of outstanding quality: laminated grès porcelain Champagne or Auvergne or cane glass, Corian® white benches, teak accessories

→ Hammam con tecnologia generatore Nuvola Smart Power ispezionabile dall'esterno  
 → Hammam technology equipped with Nuvola Smart Power steam generator accessible from outside

→ Finiture in vetri extrachiari in 10 mm per sauna e hammam  
 → Sauna and Hammam glass finish: extra clear 10mm glass

→ Finiture interne totalmente piastrellabili anche con altri rivestimenti per realizzazioni su misura  
 → Internal walls available to be tiled with other materials for made to measure projects

→ BodyLove offre tantissime possibilità di personalizzazione in termini di scelta e abbinamento dei materiali  
 → BodyLove offers countless customization options as far as choice and combination of materials

# BodyLove

SAUNA + HAMMAM  
 Design: Rodolfo Dordoni  
 with Michele Angelini

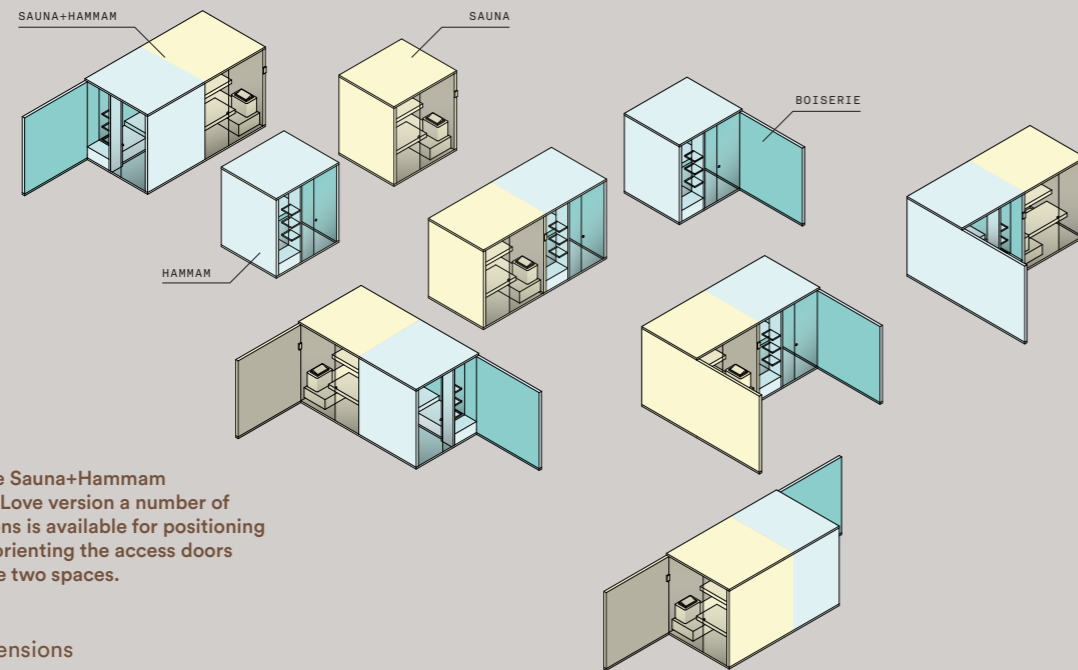

In versione Sauna+Hammam BodyLove permette diverse possibilità di orientamento e posizionamento delle porte di accesso ai due spazi.

In the Sauna+Hammam BodyLove version a number of options is available for positioning and orienting the access doors to the two spaces.

Dimensioni  
 BodyLove S:  
 CM 200 X 176 X 220 H

Dimensions  
 BodyLove S:  
 200 X 176 X H220 CM

BodyLove H:  
 CM 200 X 176 X 220 H

BodyLove H:  
 200 X 176 X H220 CM

BodyLove  
 Sauna+Hammam:  
 CM 393 X 176 X 220 H

BodyLove  
 Sauna+Hammam:  
 393 X 176 X H220 CM



→ Version:  
 BodyLove S.  
 Finishes: heat treated  
 solid wood.

La stufa della sauna di BodyLove è rivestita in ceramica smaltata, con cromie uniche: un materiale di pregio che esalta la morbida bellezza del legno. La fonte di calore, elemento di centrale importanza nella tradizione della sauna finlandese, ritorna ad occupare anche nell'estetica un ruolo di primo piano.

The BodyLove sauna heater is covered in glazed ceramic in unique colour combinations, a luxury material that enhances the soft beauty of the wood. The source of heat, the element of prime importance in the Finnish sauna tradition, has made a comeback with a new aesthetic that once again casts it in a starring role.

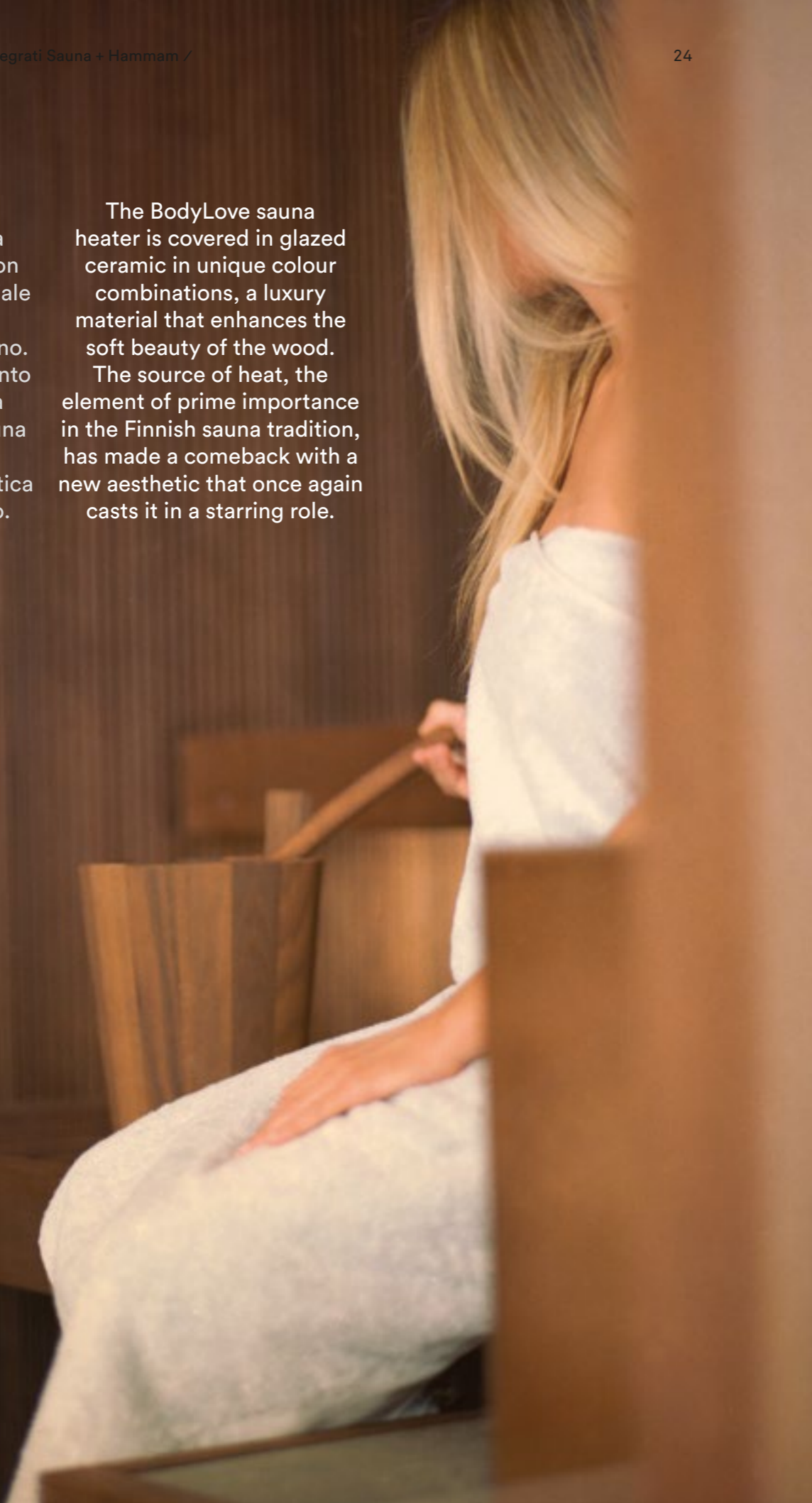

→ Version:  
BodyLove S.  
Finishes: head treated  
solid wood.





→ **BodyLove**  
Finishes:  
natural Canadian hemlock (sauna);  
heater with glazed ceramic cover;  
Corian® and fluted glass  
painted on the back (Hammam).



BodyLove guarantees steam quality that is unrivalled for its density, temperature and hygiene. The Hammam is fitted with the Nuvola Smart Power steam generator, the most high-tech system on the market.

BodyLove garantisce una qualità di vapore senza paragoni per densità, temperatura e igiene: l'hammam è dotato di generatore di vapore Nuvola Smart Power, il massimo della tecnologia disponibile.



→ **Version:**  
BodyLove Sauna+Hammam.  
The walls of the Sauna can be supplied  
in two different types of wood:  
natural Canadian hemlock  
and head treated solid wood,  
with mirror-finish surfaces on request.

La proposta di materiali di pregio come ceramica e gres stimola la percezione dello spazio benessere come ambiente in continuità con esterno, piuttosto che come elemento tecnico aggiunto e non integrato. BodyLove prevede la possibilità di una personalizzazione completa anche nella scelta dei materiali.

Such luxurious materials as ceramics and grès porcelain stimulate perception of the spa space as an environment that blends perfectly with its surroundings, rather than just an unsightly high-tech add-on. BodyLove offers the opportunity for complete personalisation including the choice of materials.





Functional, stylish, luxurious, a Rodolfo Dordoni and Michele Angelini design that engages all the senses. You can personalise your spa just as you want it. Whether in a public or private space, BodyLove makes this possible with a modular system that can put together a sauna, Turkish bath, shower and relaxation area, with up-to-the-minute features and tailor-made materials.

Funzionale, elegante, prestigioso: Rodolfo Dordoni e Michele Angelini firmano un progetto che colpisce i sensi. Personalizza come vuoi la tua Spa, privata o pubblica, grazie a BodyLove, un sistema componibile modulare che permette l'unione di sauna, bagno turco, doccia, area relax, secondo disposizioni sempre nuove e con materiali anche personalizzabili.



→ Version:  
BodyLove H.  
Finishes:  
grès porcelain Auvergne.



→ A panel of Botticino marble contains the taps and the spring and shower controls plus a copper-finish stainless steel bowl to douse yourself with cool water as you take your steam bath.





→ Logica:  
Sauna, Turkish bath,  
shower.  
Finishes:  
Sand - Soft Sand

# Logica

SAUNA + HAMMAM  
Talocci Design

**Sauna e bagno turco  
in una soluzione unica,  
collegati da un elegante spazio  
doccia. Logica contiene  
tutte le funzioni di un centro  
benessere completo,  
mantenendo un perfetto  
equilibrio tra funzionalità,  
estetica e tecnologia.**



A sauna and Turkish bath  
in one unit linked by a stylish  
shower space.

Logica boasts all the  
functions of a complete spa,  
the perfect balance  
of practicality, aesthetics  
and technology.

→ Sistema integrato con sauna, bagno turco e doccia  
 → A complete system incorporating a sauna, Turkish bath and shower

→ Tecnologia Aquasteam per la generazione del vapore, per un controllo totale della qualità  
 → Aquasteam steam generation technology, for total quality control

→ Doccia completa di soffione anticalcare e miscelatore con cartuccia progressiva e deviatore  
 → Shower complete with lime-scale-resistant shower head, mixer tap with flow regulator and diverter

→ Materiali di eccezionale qualità: legno Hemlock canadese, rivestimenti in gres laminato Slimtech® da 3,5 mm, porte in vetro temperato da 8 mm  
 → Top quality materials: Canadian hemlock wood, tiling in 3.5mm Slimtech® laminated grès porcelain, 8mm toughened glass doors

→ ESS - Effegibi Sound System per il controllo della musica direttamente dal proprio dispositivo (optional)  
 → ESS - Effegibi Sound System which delivers music from your own device (options)

→ Disponibile in sette finiture standard, o con cromie personalizzate  
 → Available in seven standard finishes or personalised colour schemes

→ Prodotto completo, disponibile anche per applicazioni su misura  
 → Complete product also available for made-to-measure solutions

# Logica

SAUNA + HAMMAM  
 Talocci Design

Dimensioni:  
 CM 373 X 250 X 226 H

Dimensions:  
 373 X 250 X H226 CM



→ Logica:  
 Sauna, Turkish bath,  
 shower.  
 Finishes:  
 Sand - Soft Sand

→ Logica:  
Sauna, Turkish bath,  
shower.  
Finishes:  
Sand - Soft Sand





→ Logica:  
Sauna, Turkish bath,  
shower.  
Finishes:  
Sand - Soft Sand

## Materiali

Logica è realizzata con tecnologie di ultima generazione e materiali di grande pregio: legno di Hemlock canadese di prima scelta e gres laminato Slimtech®, accoppiato nelle pedane a vetro temperato da 15 mm

## Materials

Logica comes with latest generation technology and top quality materials: best Canadian hemlock wood and Slimtech® laminated grès porcelain, coupled with 15mm toughened glass for the platforms.

→ Logica:  
Sauna, Turkish bath,  
shower.  
Finishes:  
Sand - Soft Sand

→ Shower complete  
with mixer tap with flow  
regulator and diverter,  
ceiling-mounted  
lime-scale-resistant shower  
head, hand-held shower  
head.

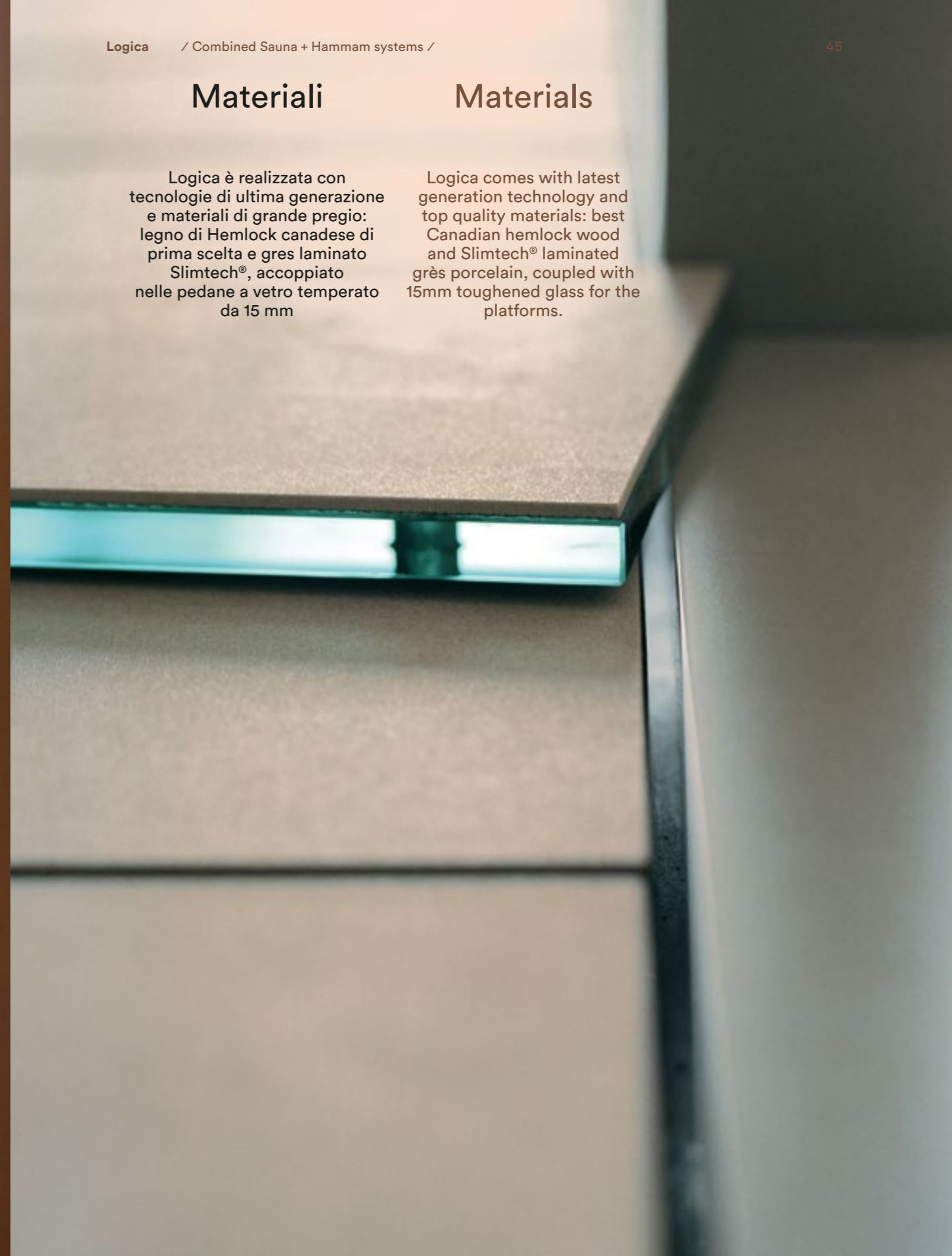



→ Sauna,  
Turkish bath, shower.  
Finishes: Stone



## Comandi Touch

Una colonna centrale racchiude i comandi touch retroilluminati di sauna, hammam e cromoterapia. Logica utilizza una tecnologia estremamente avanzata per il controllo delle funzioni, sviluppata dai tecnici Effegibi per essere di semplice e intuitivo utilizzo. Niente disturberà il vostro relax.

## Touch Controls

A central column contains the back-lit touch-screen controls for the sauna, the Hammam and colour therapy. Logica uses state-of-the-art technology for the function controls, designed to be intuitive and user-friendly by the Effegibi team of technical experts. Nothing will disturb your relaxation.





→ Logica:  
Sauna, Turkish bath,  
shower.  
Finishes:  
Sand - Soft Sand

**La qualità  
e la densità del vapore  
Effegibi  
è quello che rende  
il bagno turco un vero  
spazio di piacere**

**The quality and  
density of the steam  
produced by the  
Effegibi system makes  
the Turkish bath  
an utterly pleasurable  
experience.**



→ **Aquasteam:**  
latest-generation  
steam generator  
with spring and touch  
controls





→ Sauna space  
in top-quality Canadian  
hemlock



→ Logica:  
Sauna, Turkish bath,  
shower.  
Finishes: Stone

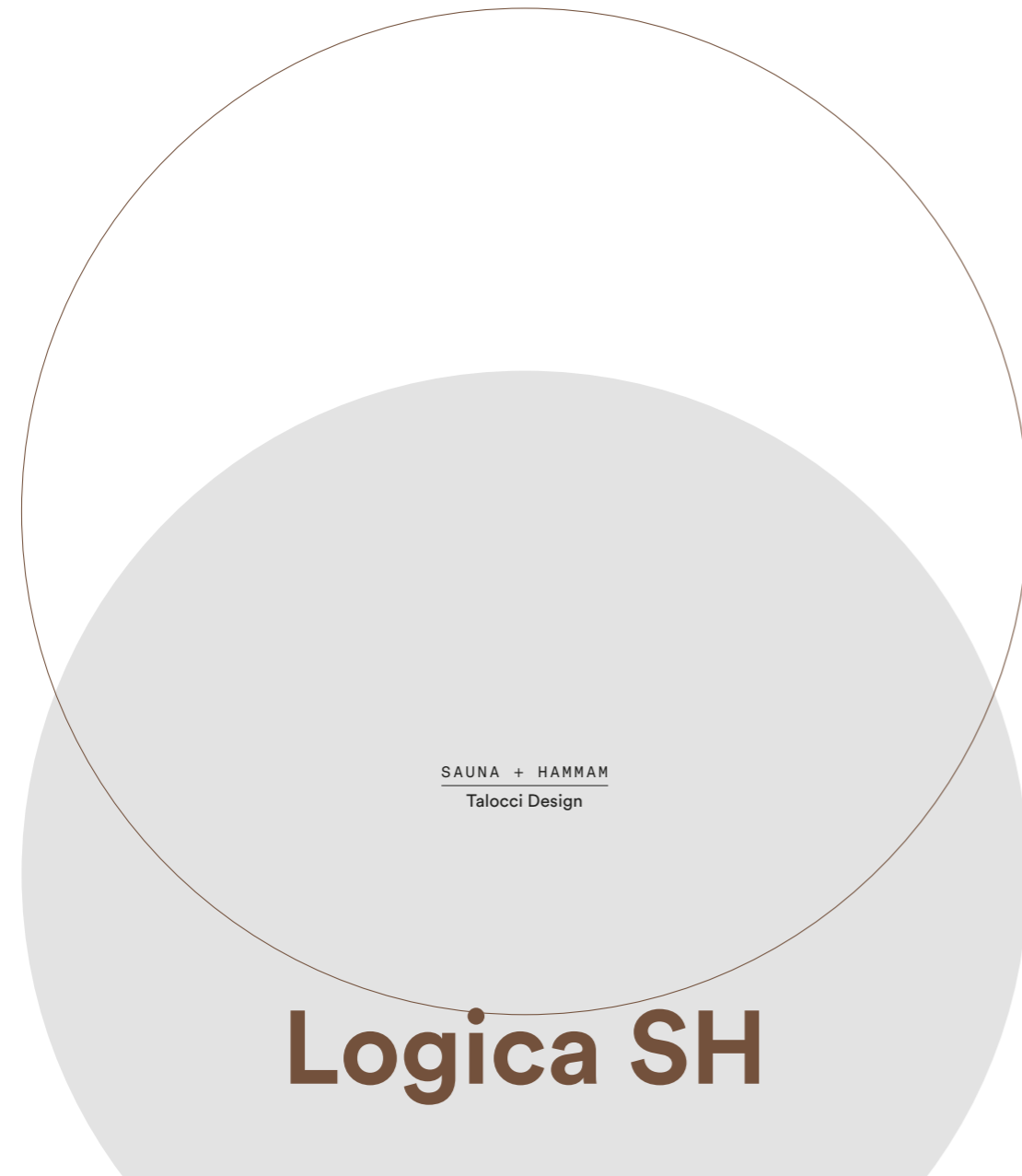

SAUNA + HAMMAM  
Talocci Design

# Logica SH

Tutta l'eleganza del sistema Logica in uno spazio più contenuto. Sauna e bagno turco diventano un vero progetto di design integrato con la tua casa.

All the elegant styling of the Logica system in a smaller space. A superbly designed sauna and Turkish bath, the perfect fit for your home.



→ Logica SH:  
Sauna, Turkish bath.  
Finishes: Cloud - White  
Cloud

→ Sistema integrato con sauna e bagno turco  
→ Combined sauna and hammam system

→ Per la generazione del vapore è installato Aquasteam, con funzione Energy Saver e sistema automatico di lavaggio caldaia  
→ The Aquasteam steam generator is installed with the Energy Saver function and automatic boiler-cleaning system

→ Disponibile in sette finiture standard, o con cromie personalizzate  
→ Available in seven standard finishes or personalised colour schemes

→ Materiali di eccezionale qualità: legno Hemlock canadese, rivestimenti in gres laminato Slimtech® da 3,5 mm, porte in vetro temperato da 8 mm  
→ Top-quality materials: Canadian hemlock wood, tiling in 3.5mm Slimtech® laminated grès porcelain, 8mm toughened glass doors

→ ESS - Effegibi Sound System per il controllo della musica direttamente dal proprio dispositivo (optional)  
→ ESS - Effegibi Sound System which delivers music from your own device (options)

→ Logica SH è un angolo di benessere della casa, versatile grazie alle tre varianti cromatiche  
→ Logica SH is an oasis of wellbeing in your own home, with three colour schemes to suit any décor

# Logica SH

SAUNA + HAMMAM

Talocci Design

Dimensioni:  
CM 373 X 171 X 226 H

Dimensions:  
373 X 171 X H226 CM

→ Logica SH:  
Sauna, Turkish bath.  
Finishes: Stone.



EFFEGIBI CUSTOM MADE

Private house  
Estoril - Cascais  
Portugal



EFFEGIBI CUSTOM MADE

Private house  
Estoril - Cascais  
Portugal



Quando in un ambiente il contenuto di vapore è superiore alla quantità d'acqua presente nell'epidermide, si forma sulla pelle uno strato di umidità che apporta calore al corpo.

L'azione contemporanea del vapore e del calore controllato aiuta la circolazione sanguigna linfatica sciogliendo le tossine e favorendone l'espulsione.

When the steam content in an environment is greater than the quantity of water in the epidermis, a layer of moisture forms on the skin warming up the body. The combined action of the steam and the controlled heat assists the blood and lymph circulation system, dissolving toxins and favouring their expulsion.





EFFEGIBI CUSTOM MADE

Relaxation Area  
Viking Star  
Viking Ocean Cruises



EFFEGIBI CUSTOM MADE

Relaxation Area  
Viking Star  
Viking Ocean Cruises



# Mid

SAUNA + HAMMAM  
Talocci Design

**In soli 3 metri Mid  
abbina sauna  
e hammam in un unico  
e prezioso oggetto di  
design. La trasparenza  
fra gli ambienti rende  
l'impatto estetico  
leggero e piacevole.**



Mid combines  
a sauna and a Hammam  
in a space of just 3 metres,  
a triumph of design.

The clear glass  
dividing the two  
environments creates  
a pleasant light and airy  
look.

→ Sistema integrato di sauna e doccia con bagno turco  
 → A complete system incorporating a sauna and a shower with Turkish bath

→ Aquasteam per la generazione del vapore: il meglio della tecnologia per il bagno turco  
 → The Aquasteam steam generator runs on the best technology for the Turkish bath

→ ESS - Effegibi Sound System per il controllo della musica direttamente dal proprio dispositivo (optional)  
 → ESS - Effegibi Sound System which delivers music from your own device (options)

→ Materiali di eccezionale qualità: legno Hemlock canadese, rivestimenti in gres laminato Slimtech® da 3,5 mm, porte in vetro temperato da 8 mm  
 → Top quality materials: Canadian hemlock wood, tiling in 3.5mm Slimtech® laminated grès porcelain, 8mm toughened glass doors

→ Disponibile in sette finiture standard, o con cromie personalizzate  
 → Available in seven standard finishes or personalised colour schemes

→ Prodotto completo, disponibile anche per applicazioni su misura  
 → Complete product also available for made-to-measure solutions

→ Spazio doccia comodo e funzionale, con miscelatore termostatico, doccia a mano e soffione doccia a soffitto 42x42 cm con funzioni pioggia e nebulizzazione  
 → Comfortable, practical shower space, with thermostatic mixer tap, hand-held and ceiling-mounted (42x42cm) shower head, with rain and nebuliser functions

# Mid

SAUNA + HAMMAM

Talocci Design

Dimensioni:  
 CM 300 X 137 X 220 H

Dimensions:  
 300 X 137 X H220 CM



→ Mid: Sauna,  
 Turkish bath.  
 Finishes:  
 Sand - Soft Sand

→ Mid: Sauna,  
Turkish bath.  
Finishes:  
Sand - Soft Sand



**Aquasteam**  
è un generatore di vapore  
ad altissime prestazioni,  
progettato per volumi  
fino a 4,5 m<sup>3</sup>, con  
un controllo totale  
su densità e igiene del  
vapore.

**Aquasteam**  
is an extremely high  
performance steam  
generator, designed  
for volumes up to 4.5 m<sup>3</sup>,  
with total hygiene  
and steam density  
control.

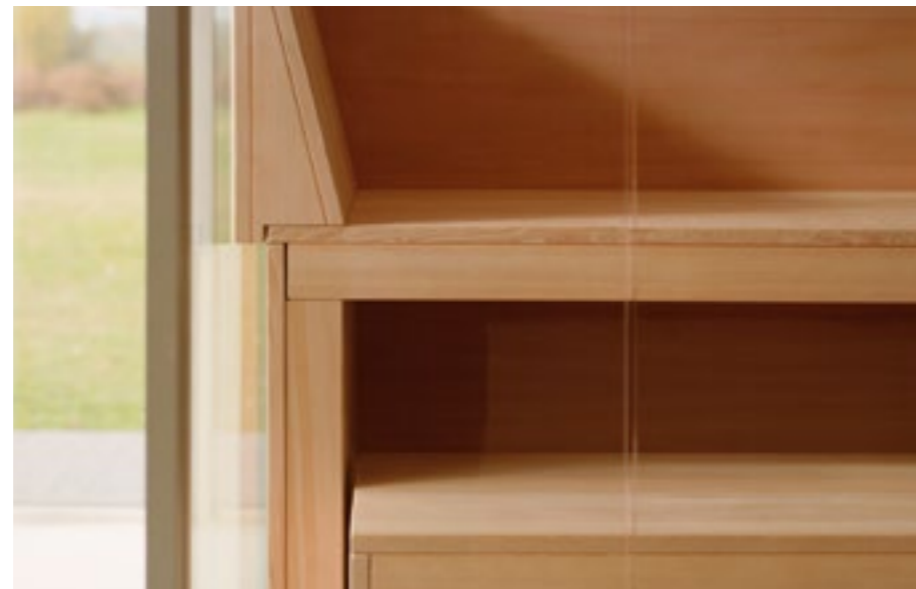

Shower complete with thermostatic mixer tap with three-way diverter, hand-held and ceiling-mounted (42x42cm) shower heads, with rain and nebuliser functions.

Doccia completa di: miscelatore termostatico con deviatore a tre vie, doccia a mano, soffione doccia a soffitto 42x42 cm con funzioni pioggia e nebulizzazione.

The bench seats are made of glass coupled with 3.5mm Slimtech® laminated grès porcelain, a material that is extremely resistant to temperature fluctuations and very pleasant to the touch.

Le sedute sono realizzate con vetro accoppiato a gres laminato Slimtech® da 3,5 mm, un materiale estremamente resistente agli sbalzi di temperatura e molto piacevole al tatto

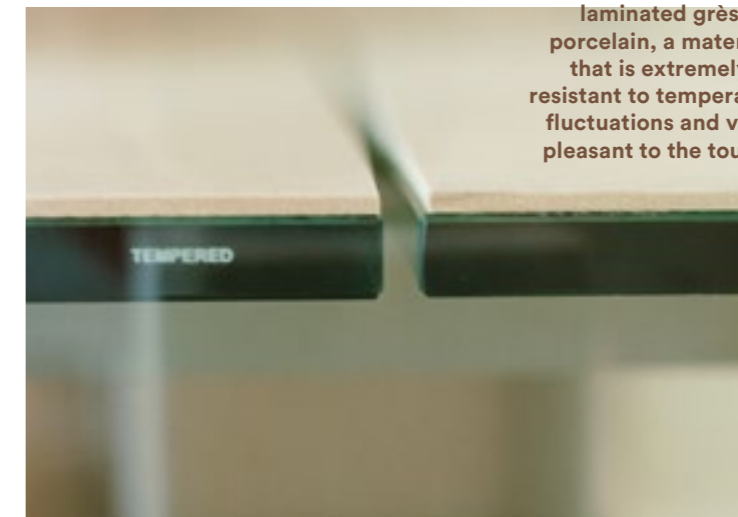

L'area hammam di Mid è uno spazio di benessere completo, che abbina le proprietà del vapore e la freschezza dell'acqua in un mix che coinvolge tutti i sensi.

The Mid Hammam area is a space designed for the utmost wellbeing, combining the beneficial properties of steam with the freshness of water to delight all the senses.



→ Mid: Sauna,  
Turkish bath.  
Finishes:  
Sand - Soft Sand

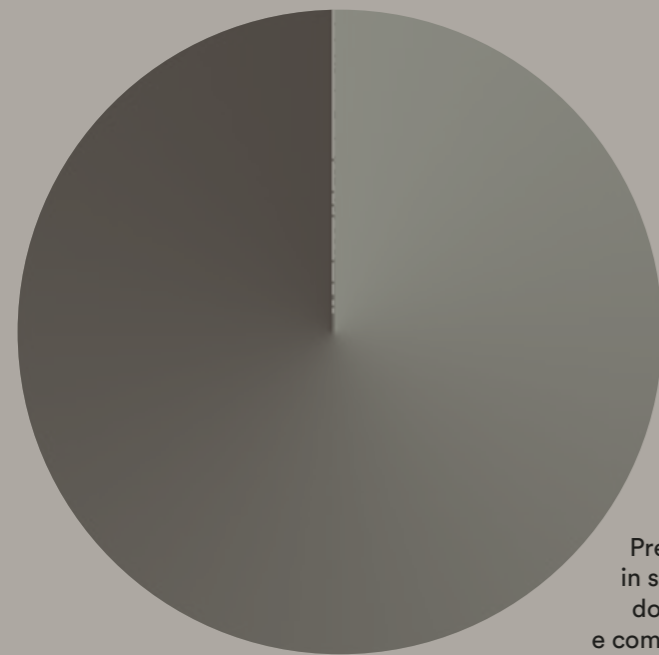

a. (60')  
Prepararsi a entrare in sauna almeno 1 ora dopo l'ultimo pasto e comunque mai a digiuno  
Enter the sauna at least one hour after the last meal, but never having fasted

a.



b.

b. (6')  
Bere acqua o tisana (tiglio, camomilla)  
Drink water or a herbal tea (linden or chamomile)



c.

c. (2')  
Doccia tiepida  
Lukewarm shower



d.

d. (1')  
Asciugarsi per aumentare la sudorazione  
Dry out to increase sweating

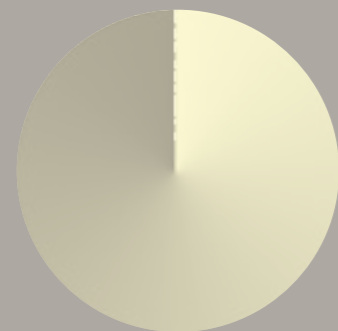

e.

e. (15')  
Sauna.  
Primo bagno di aria secca 90°C / 100°C - 20% umidità  
Sauna.  
First 90°C / 100°C - 20% humidity dry air bath



f.

f. (2')  
Doccia fresca per chiudere i pori dilatati  
Fresh shower to close the enlarged skin pores



g.

g. (10')  
Sdraiarsi nel lettino e rilassarsi  
Lay down on the bed and relax

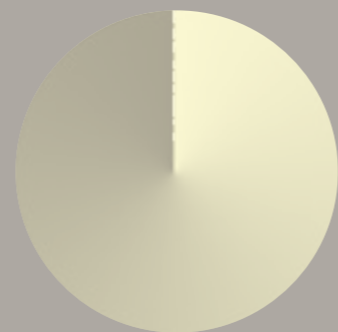

h.

h. (15')  
Sauna.  
Secondo bagno di "vapore surriscaldato" versando acqua sulle pietre roventi  
Sauna.  
Second bath of "heated steam" by putting water on the hot stones



i.

i. (2')  
Doccia fresca  
Take a cold shower

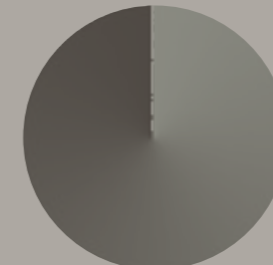

j.

j. (10')  
Sdraiarsi nel lettino e rilassarsi  
Lay down on the bed and rest



k.

k. (1')  
Bere acqua  
Drink water

Come si fa la sauna

La sauna crea un ambiente di caldo elevato e molto secco, quasi del tutto privo di umidità. Questo stimola la sudorazione e l'espulsione di tossine dal nostro corpo. Fare una doccia tiepida o fresca all'uscita dalla sauna è estremamente piacevole e tonificante.

How to take a sauna

The sauna creates a very warm, dry environment, almost completely free from humidity.

The sweating stimulated by this rids the body of toxins. After your sauna session, a warm or cool shower is an extremely pleasant way of toning up.





EFFEGIBI CUSTOM MADE

Private house  
Corvara - Alta Badia  
Italy





EFFEGIBI CUSTOM MADE

Private house  
Corvara - Alta Badia  
Italy





EFFEGIBI CUSTOM MADE

La Casa del Porto  
Lovere - Bergamo  
Italy





EFFEGIBI CUSTOM MADE

La Casa del Porto  
Lovere - Bergamo  
Italy





EFFEGIBI CUSTOM MADE

Private house  
Moscow  
Russian Federation



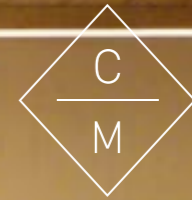

EFFEGIBI CUSTOM MADE

Excelsior Hotel Gallia  
Suite Katara  
Milan, Italy



# Logica S

SAUNA  
Talocci Design

Il rito della sauna si completa con la zona doccia, accuratamente progettata nel pieno rispetto della tradizione finlandese.

The sauna is completed with a shower area, carefully designed to be faithful to the Finnish tradition.



→ Finishes:  
Sand -  
Soft Sand



→ Sistema integrato con sauna finlandese e doccia  
 → System incorporating a Finnish sauna and shower

→ Tutta la zona sauna è rivestita in legno di Hemlock canadese, il materiale più pregiato utilizzato per le saune finlandesi  
 → The entire sauna area is clad in Canadian hemlock wood, the most highly prized material for Finnish saunas

→ ESS - Effegibi Sound System per il controllo della musica direttamente dal proprio dispositivo (optional)  
 → ESS - Effegibi Sound System which delivers music from your own device (options)

→ La struttura esterna alla sauna è disponibile in sette finiture standard, o con cromie personalizzate  
 → The outside of the sauna is available in seven standard finishes or with personalised colour schemes

→ Sauna e doccia sono due elementi che si completano: gli spazi sono distribuiti in modo che tutto sia comodo e funzionale  
 → The sauna and shower are two complementary elements, their spaces designed for the utmost comfort and practicality

# Logica S

SAUNA  
 Talocci Design

Dimensioni:  
 CM 214 X 250 X 226 H

Dimensions:  
 214 X 250 X H226 CM



→ Finishes:  
 Sand -  
 Soft Sand



# Logica H

HAMMAM  
Talocci Design

Logica H abbina la magia del bagno turco allo spazio doccia in un prodotto unico che diventa un vero angolo di benessere quotidiano.

Logica H combines the magic of the Turkish bath with a shower space in a single product that will become an amazing corner of day-to-day wellbeing.



→ Finishes:  
Sand -  
Soft Sand

→ Sistema integrato con bagno turco e doccia  
→ System incorporating a Turkish bath and shower

→ Aquasteam, la migliore tecnologia disponibile per la generazione del vapore  
→ Aquasteam, the best steam generation technology

→ ESS - Effegibi Sound System per il controllo della musica direttamente dal proprio dispositivo (optional)  
→ ESS - Effegibi Sound System which delivers music from your own device (options)

→ Materiali di eccezionale qualità: rivestimenti in gres laminato Slimtech® da 3,5 mm, porte in vetro temperato da 8 mm  
→ Top quality materials: tiling in 3.5mm Slimtech® laminated grès porcelain, 8mm toughened glass doors

→ Disponibile in sette finiture standard, o con cromie personalizzate  
→ Available in seven standard finishes or with personalised colour schemes

→ Pannello di controllo Effegibi a led luminosi per una perfetta visibilità dei simboli anche durante il bagno di vapore  
→ The Effegibi LED-lit control panel ensures the symbols are perfectly visible during the steam bath

# Logica H

HAMMAM  
Talocci Design

Dimensioni:  
CM 214 X 250 X 226 H

Dimensions:  
214 X 250 X H226 CM

→ Finishes:  
Sand -  
Soft Sand

Aquasteam is a stylish, compact steam generator. A curved glass panel houses the intuitive touch-screen controls with LED backlighting making them easy to see. Aquasteam is equipped with a spring that delivers water to the bowl, recalling the ancient tradition of the Hammam.

Aquasteam è un erogatore di vapore dal design compatto ed elegante. Una lastra di vetro curvato ospita i comandi touch, intuitivi e facilmente visibili grazie ai led retroilluminati. Aquasteam è dotato di una fonte per l'erogazione dell'acqua nella ciotola, che richiama la tradizione degli antichi hammam.



→ One S,  
in Canadian hemlock  
wood.  
Finishes:  
Cloud - White Cloud

# One

ONE S    ONE H  
Talocci Design



Due prodotti coordinati dallo stesso design elegante e razionale: One S, concepita per una massima funzionalità, e One H, che coniuga sapientemente estetica e tecnologia.

I due box possono essere facilmente abbinati per creare ambienti Spa privati o pubblici, perché consentono una grande flessibilità progettuale.

Two products brought together by the same practical, elegant design. One S, designed to be extremely practical and One H, a clever combination of aesthetics and technology.

Maximum design flexibility means finishing touches can easily be added to both cubicles to create the right spa environment, in a public or private space.

→ Un box sauna e un box hammam coordinati, abbinabili in uno stesso ambiente o utilizzabili singolarmente

→ Coordinated sauna and Hammam cubicles can be used as a pair in the same environment or separately

→ One H utilizza Aquasteam 45 per la generazione del vapore, per un controllo totale di densità e igiene

→ One H uses an Aquasteam 45 steam generator, for total steam density and hygiene control

→ Materiali di eccezionale qualità: sauna in legno Hemlock, hammam con rivestimenti in gres laminato Slimtech® da 3,5 mm

→ Top quality materials: the sauna in Canadian hemlock wood, the Hammam tiled in 3.5mm Slimtech® laminated grès porcelain

→ ESS - Effegibi Sound System per il controllo della musica direttamente dal proprio dispositivo (optional)

→ ESS - Effegibi Sound System which delivers music from your own device (options)

→ Disponibili in sette finiture standard, o con cromie personalizzate

→ Available in seven standard finishes or with a personalised colour scheme

→ Grande versatilità nelle applicazioni, in centri benessere, palestre o in casa

→ Extremely versatile, ideal for location in a spa, gym or a private home

# One

ONE S    ONE H

Talocci Design

## Dimensioni

One S:  
CM 214 X 171 X 226 H

One H:  
CM 214 X 171 X 226 H

## Dimensions

One S:  
214 X 171 X H226 CM

One H:  
214 X 171 X H226 CM



→ One H tiled in 3.5mm Slimtech® laminated grès porcelain.  
Finishes:  
Cloud - White Cloud



→ One S,  
Canadian Hemlock  
Finishes:  
Cloud - White Cloud





→ One H  
Finishes:  
Cloud - White Cloud

The perfect Turkish bath is created by optimum density steam that stays constant over time, with the temperature above 40°C.

All Effegibi Hammam steam generators have specified steam temperature and quantity to guarantee a truly relaxing, lasting experience.

→ The interior of One H is tiled in carefully-crafted Slimtech® grès porcelain to ensure contact with bare skin creates a warm, natural sensation.

Il perfetto bagno turco si ottiene quando la densità del vapore è ottimale e costante nel tempo, con una temperatura sopra i 40°C. Gli hammam Effegibi hanno temperatura e quantità di vapore dichiarata per tutti i generatori: questo garantisce un'esperienza di puro relax e una maggiore durata nel tempo.

→ L'interno di One H è rivestito in gres laminato Slimtech® opportunamente lavorato che conferisce nel contatto con il corpo nudo una piacevole sensazione naturale e calda.



→ One H  
Finishes:  
Cloud - White Cloud



→ One S  
Finishes:  
Cloud - White Cloud



# Sky

SAUNA  
Talocci Design

Una sauna con un'estetica estremamente versatile, caratterizzata da ampie vetrate che arrivano fino al soffitto: un oggetto luminoso e leggero, perfetto per ogni ambiente.

A sauna with extremely versatile design features, with wide glass panels reaching right up to the ceiling that create a light and airy feel that is perfect for any environment.



→ Version:  
Sky Glass



→ Sauna certificata, realizzata in pregiato legno canadese Hemlock e vetri temperati da 10 mm  
 → Certified sauna made of prized Canadian hemlock wood and 10mm toughened glass panels

→ Parete frontale, porta e soffitto in vetro donano a Sky estrema trasparenza e leggerezza  
 → The glass front wall, door and ceiling give Sky an extremely light, airy look

→ Disponibile in tre differenti design: Glass (solo vetro), Techno e Deco  
 → Available in three different designs: Glass only, Techno and Deco

→ ESS - Effegibi Sound System, per il controllo della musica direttamente dal proprio dispositivo (optional)  
 → ESS - Effegibi Sound System, delivers music from your own device (optional)

→ Grande versatilità, ideale per realizzazioni su misura  
 → Extremely versatile, ideal for made-to-measure solutions

# Sky

SAUNA  
 Talocci Design

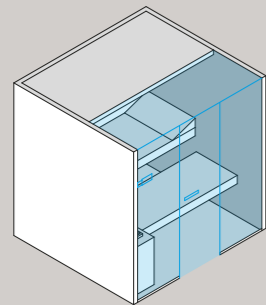

Glass

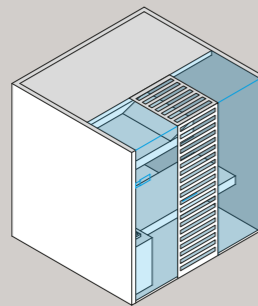

Techno

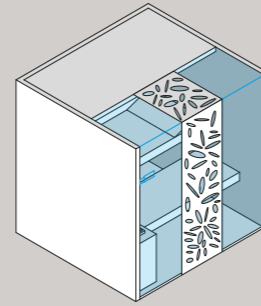

Deco

#### Dimensioni:

CM 200 X 180 X 201 H  
 CM 200 X 150 X 201 H  
 CM 170 X 130 X 201 H  
 CM 130 X 130 X 201 H  
 SU MISURA

#### Dimensions:

200 X 180 X H201 CM  
 200 X 150 X H201 CM  
 170 X 130 X H201 CM  
 130 X 130 X H201 CM  
 MADE-TO-MEASURE

→ Le tre versioni di Sky, rendono la linea facilmente abbinabile ad ogni stile d'arredo. Personalità ed eleganza in ogni situazione abitativa.

→ The three versions of Sky, enable these models to fit perfectly into any interior design environment, lending personality and style to any location.





→ Version:  
Sky Glass



→ Version:  
Sky Techno



→ Version:  
Sky Deco

## The choice of wood

Wood to be used in a sauna must have specific properties of heat absorption and resistance to stress caused by temperature fluctuations. Effegibi carries out all the necessary tests in-house to guarantee the materials are capable of long life and that they meet all the aesthetic needs of a perfect sauna. From Canadian hemlock to the traditional Swedish pine, over ten different types of wood, always of top quality, are selected by Effegibi and subjected to rigorous quality control to ensure the highest possible quality standard.

### La scelta del legno

Il legno, per essere utilizzato nella sauna, deve avere precise caratteristiche di assorbimento del calore e di resistenza allo stress causato dagli sbalzi di temperatura. Effegibi effettua internamente tutti i test necessari per garantire che i materiali siano adeguati per durare nel tempo e che rispettino le caratteristiche estetiche necessarie a realizzare saune perfette. Dall'hemlock canadese al tradizionale abete di Svezia, più di dieci tipologie di legno esclusivamente di prima scelta vengono selezionate da Effegibi e sottoposte a rigorosi controlli di qualità per offrire uno standard di altissimo livello qualitativo.



EFFEGIBI CUSTOM MADE

La Casa del Porto  
Lovere - Bergamo  
Italy



→ Canadian hemlock wood and 10mm toughened glass panels

# Sky Corner

SAUNA  
Talocci Design

**Nuovo modello della linea Sky, con una superficie vetrata ancora più ampia: un vero e proprio angolo trasparente di luce e benessere.**

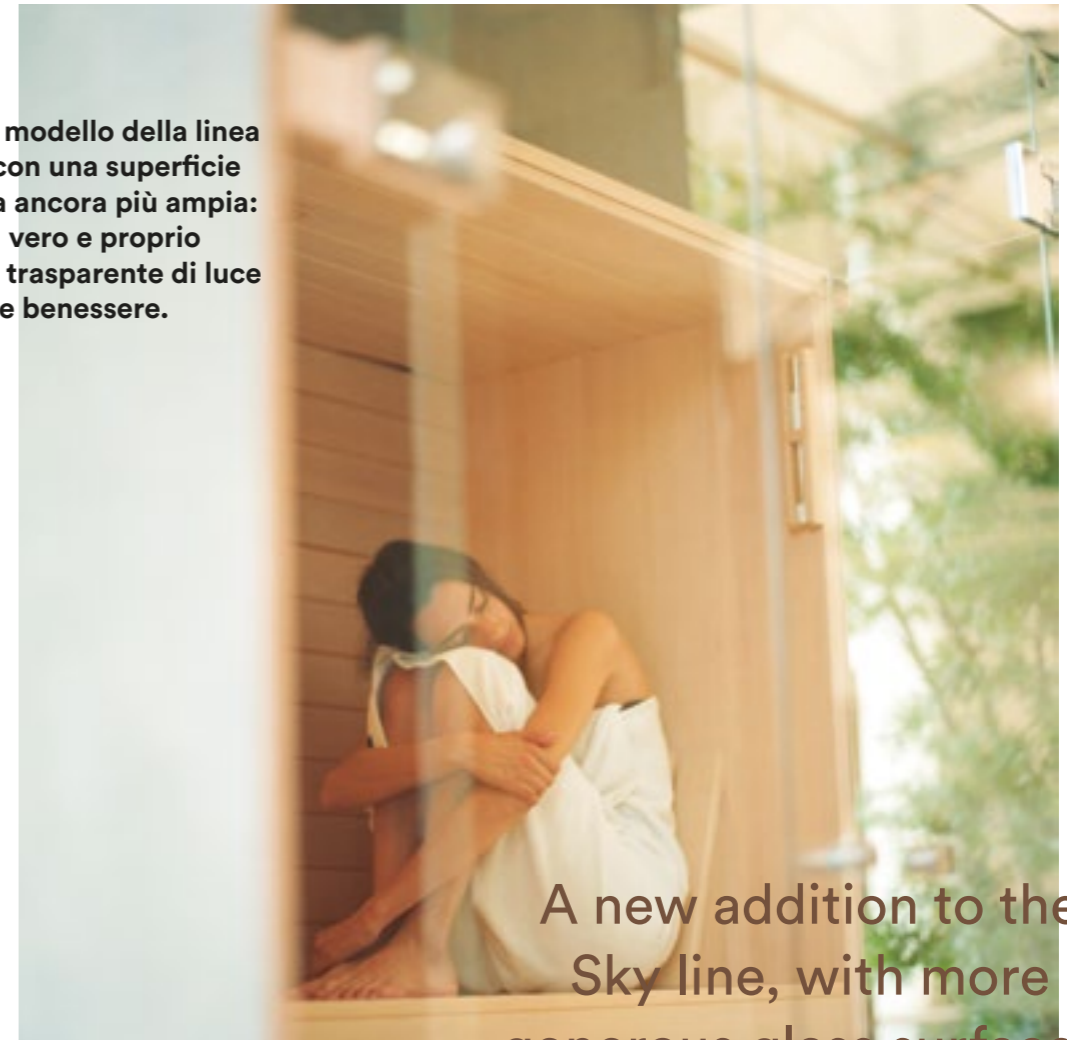

A new addition to the Sky line, with more generous glass surfaces, a corner radiating light and wellbeing.

→ Sauna certificata, realizzata in pregiato legno canadese Hemlock e vetri temperati 10 mm  
 → Certified sauna made of prized Canadian hemlock wood and 10mm toughened glass panels

→ Superficie vetrata estremamente ampia: parete frontale, porta, soffitto e parete laterale  
 → Extremely generous glass surfaces: front wall, door, ceiling and side wall

→ ESS - Effegibi Sound System, per il controllo della musica direttamente dal proprio dispositivo (optional)  
 → ESS - Effegibi Sound System, delivers music from your own device (optional)

→ Grande versatilità, ideale per realizzazioni su misura

→ Extremely versatile, ideal for made-to-measure solutions

# Sky Corner

SAUNA  
 Talocci Design

## Dimensioni:

CM 200 X 180 X 201 H  
 CM 200 X 150 X 201 H  
 CM 170 X 130 X 201 H  
 CM 130 X 130 X 201 H  
 SU MISURA

## Dimensions:

200 X 180 X H201 CM  
 200 X 150 X H201 CM  
 170 X 130 X H201 CM  
 130 X 130 X H201 CM  
 MADE-TO-MEASURE





→ The Sky Corner interior can be enhanced with colour therapy and under-bench LED lighting (optional)





→ The larger glass surfaces emphasise the design features of this line.





EFFEGIBI CUSTOM MADE

Private house  
Münster  
Germany



→ Model:  
heat-treated  
aspen wood  
with outside shelves

# Air

SAUNA  
Talocci Design

Air è una sauna dal design originale e contemporaneo, caratterizzata dalla sospensione delle sedute e dalla simmetria delle linee, con la stufa in posizione centrale: la leggerezza diventa il carattere dominante.



The Air sauna is an original, contemporary design which, as the name implies, features a light and airy feel created by the suspended seating and symmetrical lines with the heater in a central position.

→ Nuova linea di saune firmata Talocci design  
→ A new line of Talocci Design saunas

→ Le panche sospese alleggeriscono il design e consentono l'installazione sul pavimento esistente  
→ The suspended benches create a lightweight design enabling the sauna to be installed on existing flooring

→ La stufa in posizione centrale fa di Air un luogo di incontro, dove rilassarsi in compagnia  
→ The centrally placed heater makes Air the ideal meeting place to relax in company

→ Arredamenti realizzati in pregiato legno Aspen al naturale o termotrattato, molto resistente nel tempo  
→ The fittings are made of luxurious aspen wood, either natural or heat-treated for a long life

→ ESS - Effegibi Sound System, per il controllo della musica direttamente dal proprio dispositivo (optional)  
→ ESS - Effegibi Sound System, delivers music from your own device (optional)

→ I piani delle panche diventano all'esterno un portasciugamani e un funzionale piano di appoggio  
→ The bench seats project outside, creating a handy towel holder and shelf

→ Ampie superfici vetrate a tutta altezza in cristallo temperato da 10 mm  
→ Ample glass surfaces in 10mm toughened glass

→ Le fonti luminose a Led posizionate sotto le panche esaltano la leggerezza dell'ambiente  
→ The Led lighting underneath the benches enhances the light and airy atmosphere

# Air

SAUNA  
Talocci Design

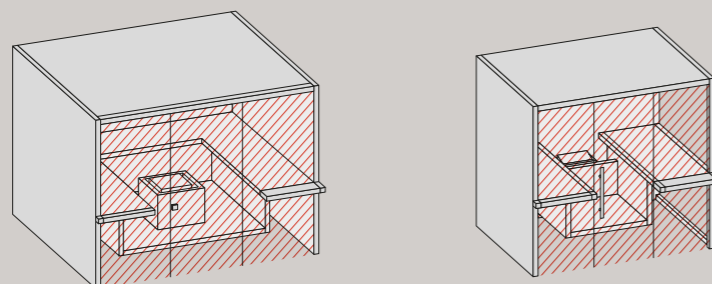

#### Dimensioni:

CM 283 X 252 X 213 H  
CM 247 X 182 X 213 H  
CM 217 X 162 X 213 H  
SU MISURA

#### Dimensions:

283 X 252 X H213 CM  
247 X 182 X H213 CM  
217 X 162 X H213 CM  
MADE-TO-MEASURE



→ Model:  
heat-treated aspen wood fittings  
teak wood walls  
and 10mm toughened glass side



→ Model:  
heat-treated aspen wood  
fittings  
teak wood walls



→ **Model:**  
natural aspen wood  
fittings  
tulipier walls  
and 10mm toughened  
glass side

→ **Model:**  
natural aspen wood  
fittings  
tulipier walls





→ The bench seats project outside, creating a handy towel holder and shelf

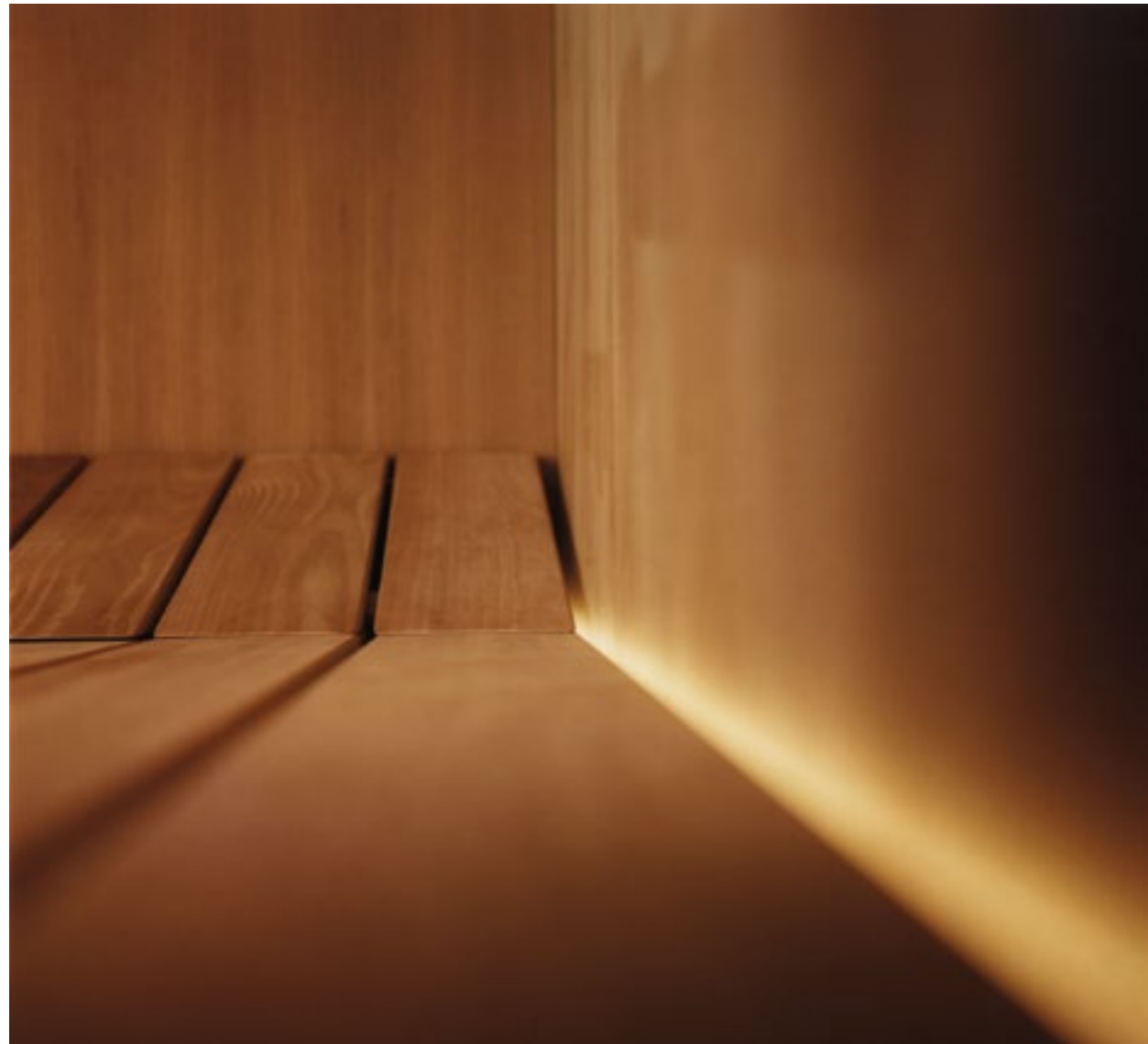





→ Model:  
heat-treated aspen wood  
fittings  
teak wood walls



→ Model:  
natural aspen wood  
fittings  
tulipier walls



Saune resistenti e pratiche,  
il cui design elegante si integra  
facilmente con ogni tipo di  
ambiente: è la linea Effegibi  
dedicata ad alberghi, SPA, centri  
sportivi e palestre.

A tough, practical  
sauna whose stylish  
look fits easily into any  
environment.  
This is the line Effegibi  
has designed especially  
for hotels, spas, sports  
centres and gyms.

# Gym

SAUNA  
Talocci Design

→ Sauna certificata IMQ, realizzata in pregiato legno canadese Hemlock, molto resistente nel tempo  
 → IMQ certified sauna made of prized Canadian hemlock wood that is extremely long-lasting

→ Le panche e le protezioni hanno sistemi meccanici semplici di rimozione, per una pulizia giornaliera veloce e pratica  
 → The benches and protective panels have mechanical systems for easy removal, for fast, practical daily cleaning

→ ESS - Effegibi Sound System, per il controllo della musica direttamente dal proprio dispositivo (optional)  
 → ESS - Effegibi Sound System, delivers music from your own device (optional)

→ Grande versatilità, ideale per realizzazioni su misura anche di grandi dimensioni  
 → Extremely versatile, ideal for made-to-measure solutions, including large sizes

# Gym

SAUNA  
 Talocci Design

## Dimensioni:

CM 300 X 200 X 216 H  
 CM 250 X 200 X 216 H  
 CM 200 X 150 X 216 H  
 SU MISURA

## Dimensions:

300 X 200 X H216 CM  
 250 X 200 X H216 CM  
 200 X 150 X H216 CM  
 MADE-TO-MEASURE





→ Easy to remove benches for quick cleaning



EFFEGIBI CUSTOM MADE

Virgin Active  
Milan  
Italy



→ **Finish:**  
Canadian hemlock.  
**Optional:**  
side glass panel

# Auki

SAUNA  
Talocci Design

**Costruita totalmente in legno pregiato di Abete di Svezia oppure Hemlock canadese senza nodi, Auki combina l'antica tradizione delle saune nordeuropee con un design moderno.**



Built entirely from highly-prized Swedish pine or knot-free Canadian hemlock,

Auki is the perfect blend of the ancient Scandinavian sauna tradition and up-to-the-minute design.

→ **Sauna certificata** IMQ, realizzata in legni pregiati e vetrate in cristalli temperati da 8 mm  
 → IMQ certified sauna made of highly-prized wood and 8mm toughened glass panels

→ **Pareti interne e esterne** caratterizzate da doghe di larghezze variabili  
 → Inner and outer walls feature slats of variable width

→ **ESS - Effegibi Sound System**, per il controllo della musica direttamente dal proprio dispositivo (optional)  
 → ESS - Effegibi Sound System, delivers music from your own device (optional)

→ **Auki si adatta facilmente alle necessità dello spazio a disposizione, anche per applicazioni su misura**

→ Auki can easily be adapted to fit the available space, also for made-to-measure solutions

# Auki

SAUNA  
 Talocci Design

## Dimensioni:

CM 228 X 170 X 201 H  
 CM 202 X 152 X 201 H  
 CM 189 X 126 X 201 H  
 CM 128 X 126 X 201 H  
 SU MISURA

## Dimensions:

228 X 170 X H201 CM  
 202 X 152 X H201 CM  
 189 X 126 X H201 CM  
 128 X 126 X H201 CM  
 MADE-TO-MEASURE

→ **Finish:** Canadian hemlock  
**Optional:** side glass panel



Le saune Auki sono caratterizzate dagli interni particolarmente accoglienti e doghe di diverse dimensioni.

Auki saunas have particularly welcoming interiors with wooden slats of various sizes.



Finish: Swedish pine





→ **Finish:**  
Swedish pine



Auki è dotata di un'elegante maniglia a bordo porta, che lascia libere le vetrate e non altera la pulizia del design esterno.

Auki has a stylish edge-mounted door handle that doesn't interrupt the glass panels, preserving the clean lines.



## Natural materials

A sauna is subjected to massive thermal stress with an interior temperature that can reach 100°C.

This is why the materials it is made of are a determining factor in its quality. Plastic components are never used in Effegibi saunas because at high temperatures they can emit noxious substances. In contrast, natural wood guarantees a healthy environment, is pleasant to the touch and is not altered over time.

## Materie naturali

Le saune subiscono enormi sollecitazioni termiche, con una temperatura interna che può arrivare fino a 100 °C. Per questo i materiali che la compongono sono un fattore determinante di qualità.

Nelle saune Effegibi non vengono mai utilizzati componenti plastici, poiché a temperature elevate potrebbero rilasciare sostanze nocive. Al contrario, i legni naturali garantiscono un ambiente sano, piacevole al tatto, che resta a lungo inalterato.



EFFEGIBI CUSTOM MADE

Relaxation Area  
Britannia  
P&O Cruises



EFFEGIBI CUSTOM MADE

Regina Hotel Baglioni  
Rome  
Italy



EFFEGIBI CUSTOM MADE

Tenuta Le Cave  
Tregnago - Verona  
Italy



# Biosauna

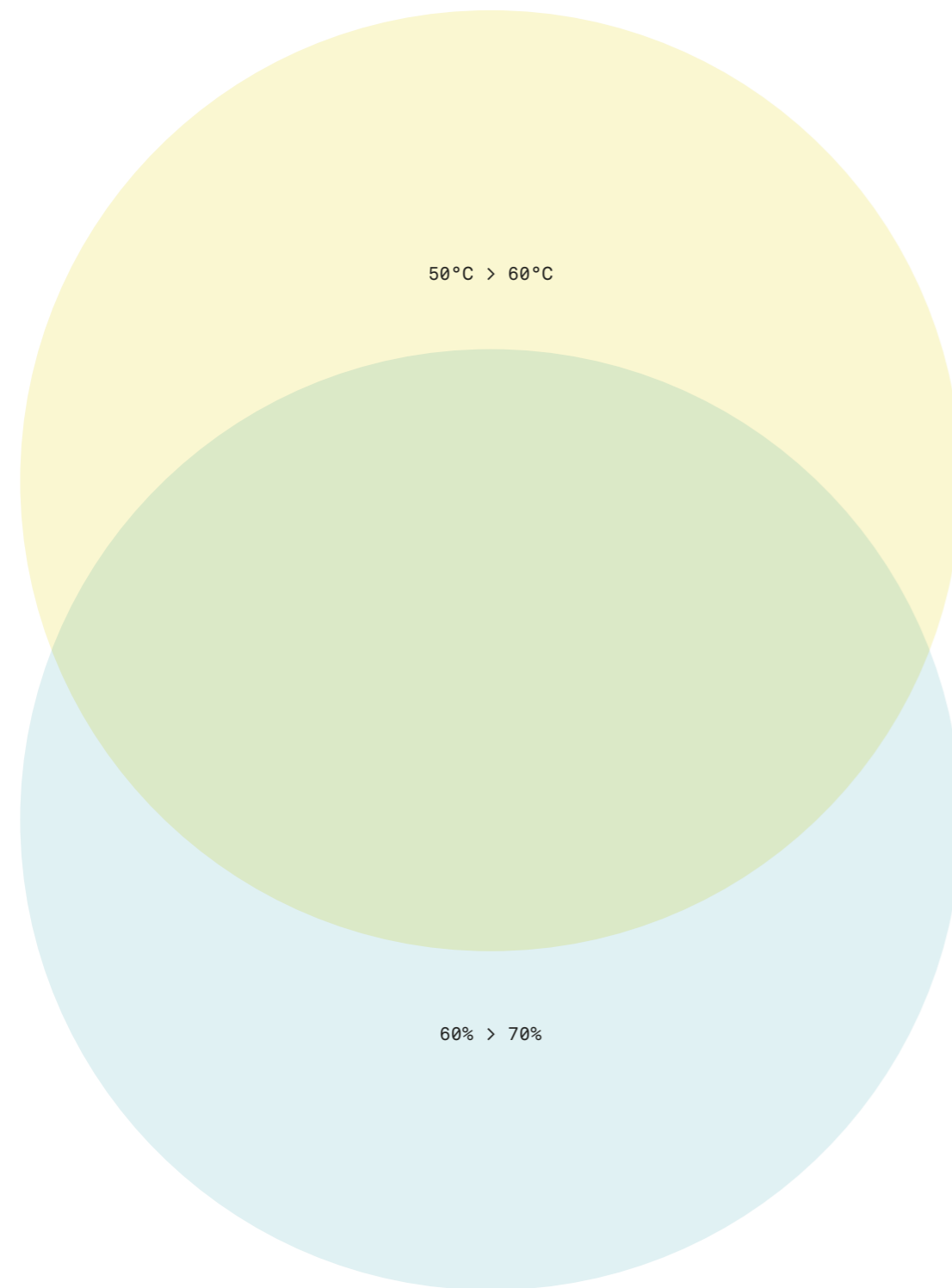

La Biosauna è una sauna con livelli di temperatura contenuti tra i 50 e i 60° C e un'umidità di circa 60-70%. Grazie al vaporizzatore integrato, impostando la temperatura preferita, la stufa Bio creerà l'equilibrio perfetto fra calore ed umidità. Il sistema combinato Effegibi consente la scelta tra Biosauna, un percorso a metà strada fra la sauna finlandese e la natura mediterranea del bagno di vapore, o sauna tradizionale, caratterizzata da temperature fino a 100 °C con bassa umidità. Il sistema combinato può essere applicata a tutte le saune di Effegibi.

The Bio-sauna is a sauna whose temperature ranges from 50 to 60°C with humidity between 60-70%. The built-in vaporiser allows you to set your preferred temperature and the Bio heater creates the perfect balance between heat and humidity. The combined Effegibi system allows you to choose between a Bio-sauna, a halfway house between the Finnish sauna and the Mediterranean nature of the steam bath, or a traditional sauna with low humidity and a temperature of up to 100°C. This combined system can be installed in all Effegibi saunas.

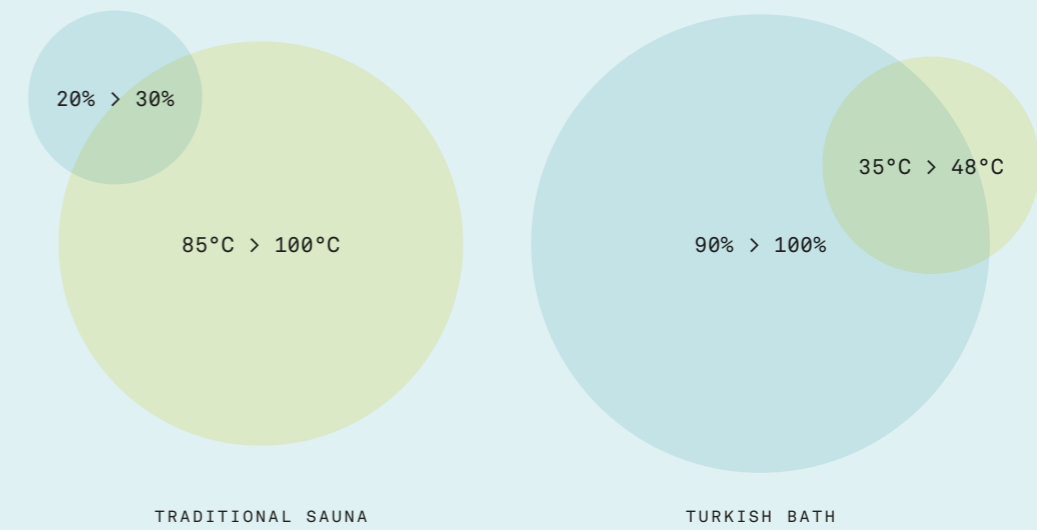

TRADITIONAL SAUNA

TURKISH BATH

→ La Biosauna può essere applicata a tutte le saune Effegibi

→ The Bio-sauna can be installed in all Effegibi saunas.





→ Version:  
Carrara marble with  
rain-effect glass

# Topkapi

HAMMAM  
Design Rodolfo Dordoni  
with Michele Angelini

Topkapi represents  
the luxury of the  
traditional Hammam,  
its walls lined  
with Carrara, Marquina  
or Botticino marble  
and unequalled  
performance from the  
steam generator.



**Il vero lusso degli antichi hammam  
è rappresentata da Topkapi:  
rivestimenti in marmo Carrara,  
Marquina o Botticino  
e uno standard qualitativo senza  
uguali nella generazione del  
vapore.**



→ Bagno turco completo di doccia, fonte, panche e cromoterapia

→ Turkish bath complete with shower, spring, benches and colour therapy

→ Materiali di altissimo livello: marmo in tre varianti, acciaio, vetro temperato, legno Teck della Birmania naturale

→ Materials of outstanding quality: three different kinds of marble, steel, toughened glass, natural Burmese teak

→ Vetrate interne di sfondo disponibili in doppia finitura: specchio e bianco

→ Inner back glass panels available in either white or mirrored glass

→ Vetri esterni disponibili sia completamente trasparenti, sia in finitura rain semi-opaca

→ Outer panels available in transparent or rain-effect semi-opaque glass

→ Topkapi è dotato di una fonte rivestita in marmo di prima scelta, completa di ciotola in acciaio finitura ramata

→ Topkapi comes with a spring clad in top quality marble, complete with a copper-finish steel bowl

→ Topkapi comprende ESS - Effegibi Sound System, per il controllo della musica direttamente dal proprio dispositivo

→ Topkapi includes the ESS - Effegibi Sound System which delivers music from your own device

→ Pannello touch intuitivo e retroilluminato per gestire vapore, temperature, luce e cromoterapia

→ Intuitive, back-lit touch control panel operates the steam, temperature, lighting and colour therapy

→ Generatore di vapore integrato nella colonna che risponde ad uno standard qualitativo unico

→ Unique quality delivered by the steam generator built into the column

# Topkapi

HAMMAM

Design Rodolfo Dordoni  
with Michele Angelini

## Dimensioni:

CM 193 X 130 X 220 H

CM 153 X 130 X 220 H

CM 193 X 90 X 220 H

CM 153 X 90 X 220 H

## Dimensions:

193 X 130 X H220 CM

153 X 130 X H220 CM

193 X 90 X H220 CM

153 X 90 X H220 CM



→ Version:  
Carrara marble  
with rain-effect  
glass



42°

Solo dopo aver raggiunto almeno la temperatura di 42 gradi potrete godere appieno della pratica del bagno turco.

La quantità e la qualità del vapore prodotto da Topkapi consente di impostare la temperatura dai 42 fino a 48 gradi per godere al massimo dei benefici di questa pratica antica.

You can only enjoy the benefits and pleasure of a Turkish bath to the full once the steam has reached a temperature of 42 °C. The volume and quality of steam produced by Topkapi enables the temperature to be set at between 42 and 48 degrees to get the maximum benefit from this ancient experience.



Version: Marquina  
marble with rain-effect  
glass



Marble is the star of the Topkapi just as it was in Turkey's most luxurious Hammams of yesteryear. This amazingly resistant, long-lasting material feels particularly good to the touch further enhancing the pleasure of your Turkish bath.

Il marmo è protagonista in Topkapi come lo è negli hammam storici più ricchi della Turchia. Questo straordinario materiale, estremamente longevo e resistente, ha una speciale resa tattile che amplifica il piacere del bagno turco.

Version: Marquina marble with rain-effect glass





→ H-Medium  
Hammam with shower.  
Version:  
Cloud - White Cloud

# H

HAMMAM  
Talocci Design

A line of Hammams delivering professional performance, complete with shower and colour therapy, the ideal complement to a home bathroom with its own spa area.

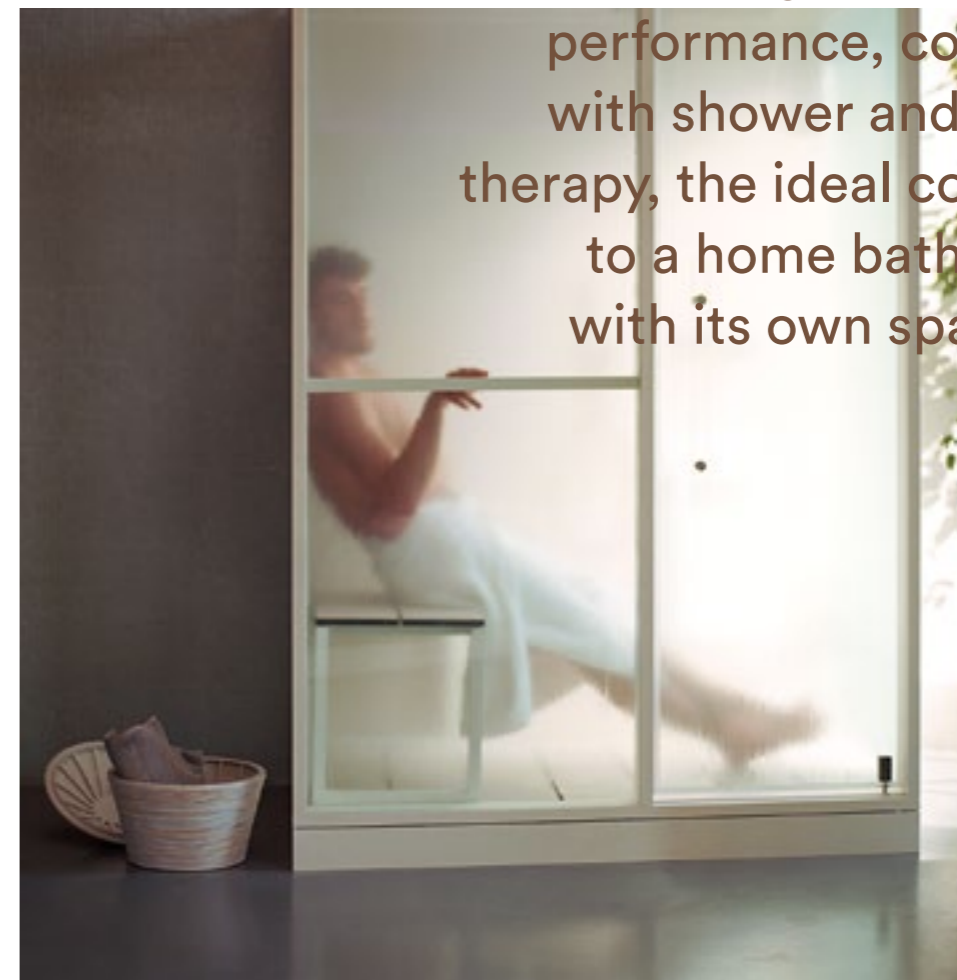

**Serie di hammam con prestazioni professionali, completi di doccia e cromoterapia, ideali per completare il bagno di casa con un'area dedicata al benessere.**

→ Hammam completo di doccia e cromoterapia  
 → Hammam complete with shower and colour therapy

→ Tecnologia Aquasteam per la generazione del vapore: il massimo del controllo sulla qualità del tuo vapore  
 → Aquasteam steam generator technology for maximum control over the quality of your steam

→ Interno e arredi in Gres laminato 3,5 mm, Porte in vetro temperato 8 mm  
 → Interior and fittings in 3.5mm laminated grès porcelain, 8mm toughened glass doors

→ Disponibile in sette varianti cromatiche  
 → Available in seven colour schemes

→ Spazio doccia comodo e funzionale, con miscelatore termostatico, doccia a mano e soffione doccia a soffitto 42x42 cm con funzioni pioggia e nebulizzazione  
 → Comfortable, practical shower space with thermostatic mixer tap, hand-held and ceiling-mounted (42x42cm) shower heads, with rain and nebuliser functions

# H

HAMMAM  
 Talocci Design

#### Dimensioni

##### H-Large:

CM 173 X 102 X 220 H

##### H-Medium:

CM 152 X 102 X 220 H

##### H-Small:

CM 131 X 92 X 220 H

#### Dimensions

##### H-Large:

173 X 102 X H220 CM

##### H-Medium:

152 X 102 X H220 CM

##### H-Small:

131 X 92 X H220 CM



→ H-Medium Hammam with shower Version: Cloud - White Cloud

→ H-Medium  
Hammam with shower  
Version:  
Cloud - White Cloud

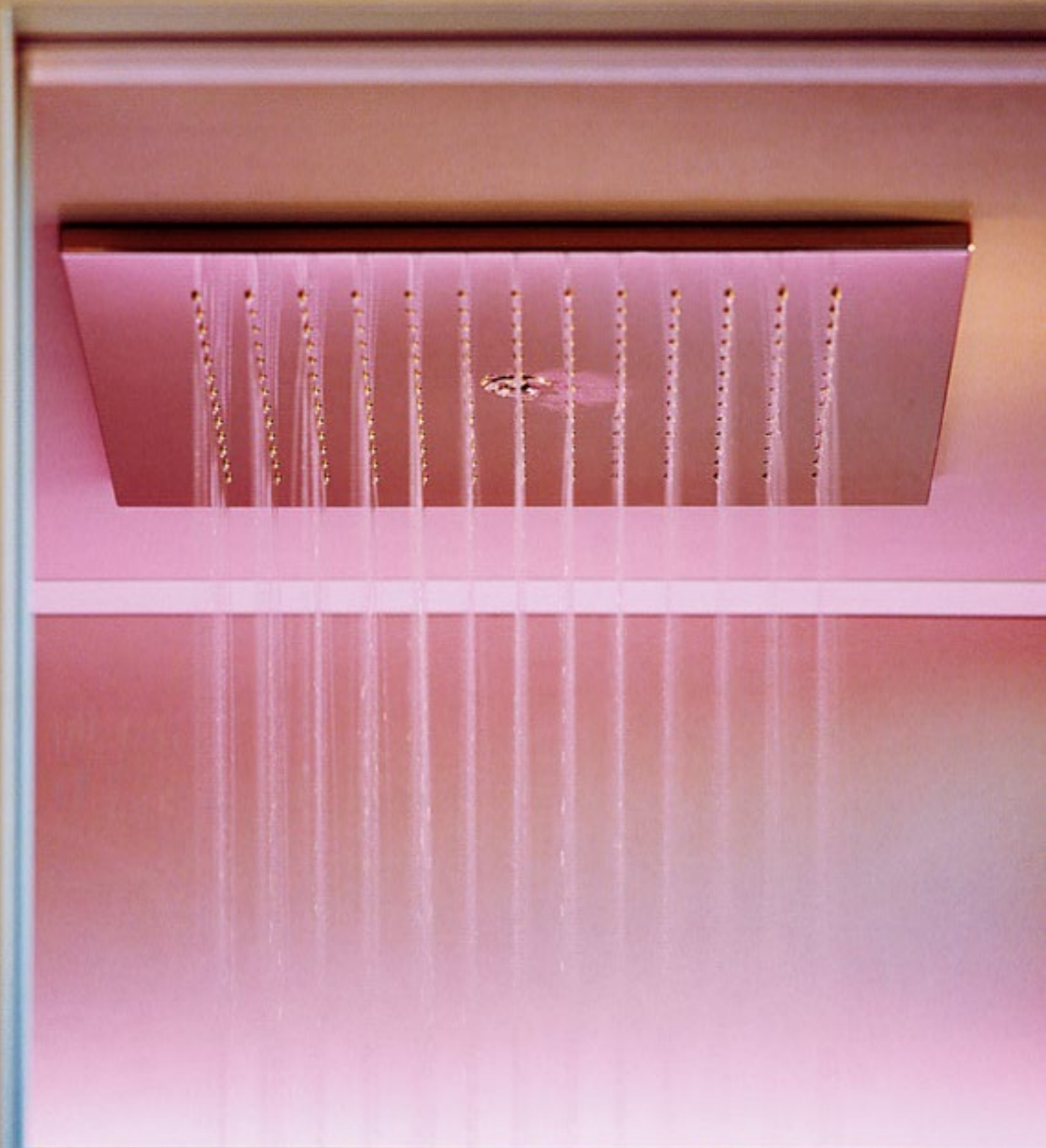

→ H-Medium  
Hammam with shower.  
Version:  
Cloud - White Cloud



La ciotola per bagnarsi  
con acqua fresca  
durante il bagno  
turco evoca le origini  
dell'hammam: la sua  
funzione è legata  
all'utilizzo dell'acqua  
nella pratica di questo  
antichissimo rito  
purificatore.

The bowl for dousing  
yourself with cool  
water during your  
Turkish bath evokes the  
historic origins  
of the Hammam  
in which water was an  
important feature of  
this ancient purification  
ritual.





## Steam generators

The Effegibi experience guarantees the essential elements for a quality Hammam

1 \_\_\_\_\_

Generating the right amount of steam

2 \_\_\_\_\_

Maintaining the right temperature

3 \_\_\_\_\_

Dealing with lime scale

4 \_\_\_\_\_

Controlling energy consumption

## Generatori di vapore

L'esperienza Effegibi garantisce gli elementi basilari per un hammam di qualità

1 \_\_\_\_\_

Corretta quantità di vapore prodotto

2 \_\_\_\_\_

Mantenimento della temperatura

3 \_\_\_\_\_

Gestione del calcare

4 \_\_\_\_\_

Controllo del consumo energetico

### Quality of steam

1 \_\_\_\_\_ 2 \_\_\_\_\_

A perfect Hammam is achieved when the steam makes it possible to reach a temperature above 40°C. In Effegibi products the temperature can be set on a scale from 42 to 48°C. The smart steam management system, the fruit of many years of R&D, ensures even heat distribution inside the Turkish bath.

### Lime scale and hygiene

3 \_\_\_\_\_

Exclusive Effegibi technology has produced a unique system without mechanical filters on the generators and no need for frequent maintenance. All the boilers are stainless steel and a sophisticated system fills and empties the boiler with clean cold water every time it is used. This notably reduces the need for cleaning and maintenance, as well as ensuring the interior environment is perfectly hygienic.

### Optimised management of energy consumption

4 \_\_\_\_\_

Each Effegibi steam generator has an Energy Saver function. The maximum power of the generator is used to bring the water to boiling point and reach the set temperature. While it is functioning the energy input is reduced to a half or a third, depending on the model, while keeping the steam flow constant.

### Qualità del vapore

1 \_\_\_\_\_ 2 \_\_\_\_\_

Un perfetto hammam si ottiene quando il vapore consente di raggiungere una temperatura superiore ai 40°C. Nei prodotti Effegibi la temperatura è programmabile in una scala che va dai 42 ai 48°C. La sapiente gestione del vapore, frutto di anni di ricerca, ottimizza l'omogeneità del calore all'interno del bagno turco.

### Calcare e igiene

3 \_\_\_\_\_

La tecnologia esclusiva Effegibi, unica al mondo, consente di evitare filtri meccanici sul generatore e manutenzioni frequenti. Grazie a sistemi sofisticati, la caldaia (rigorosamente in acciaio inox) viene caricata e scaricata con acqua fredda e pulita a ogni utilizzo. Questo riduce notevolmente la necessità di interventi di pulizia e manutenzione, oltre a garantire una perfetta igiene all'interno dell'ambiente.

### Gestione ottimizzata del consumo energetico

4 \_\_\_\_\_

Ogni generatore di vapore Effegibi è dotato di una funzione Energy Saver. La potenza massima del generatore viene sfruttata per portare in ebollizione l'acqua e raggiungere la temperatura impostata. Durante il funzionamento l'assorbimento viene ridotto alla metà o anche a un terzo, a seconda del modello di prodotto, pur mantenendo costante il getto di vapore.

La scelta di generatori di vapore Effegibi

The choice of Effegibi steam generators

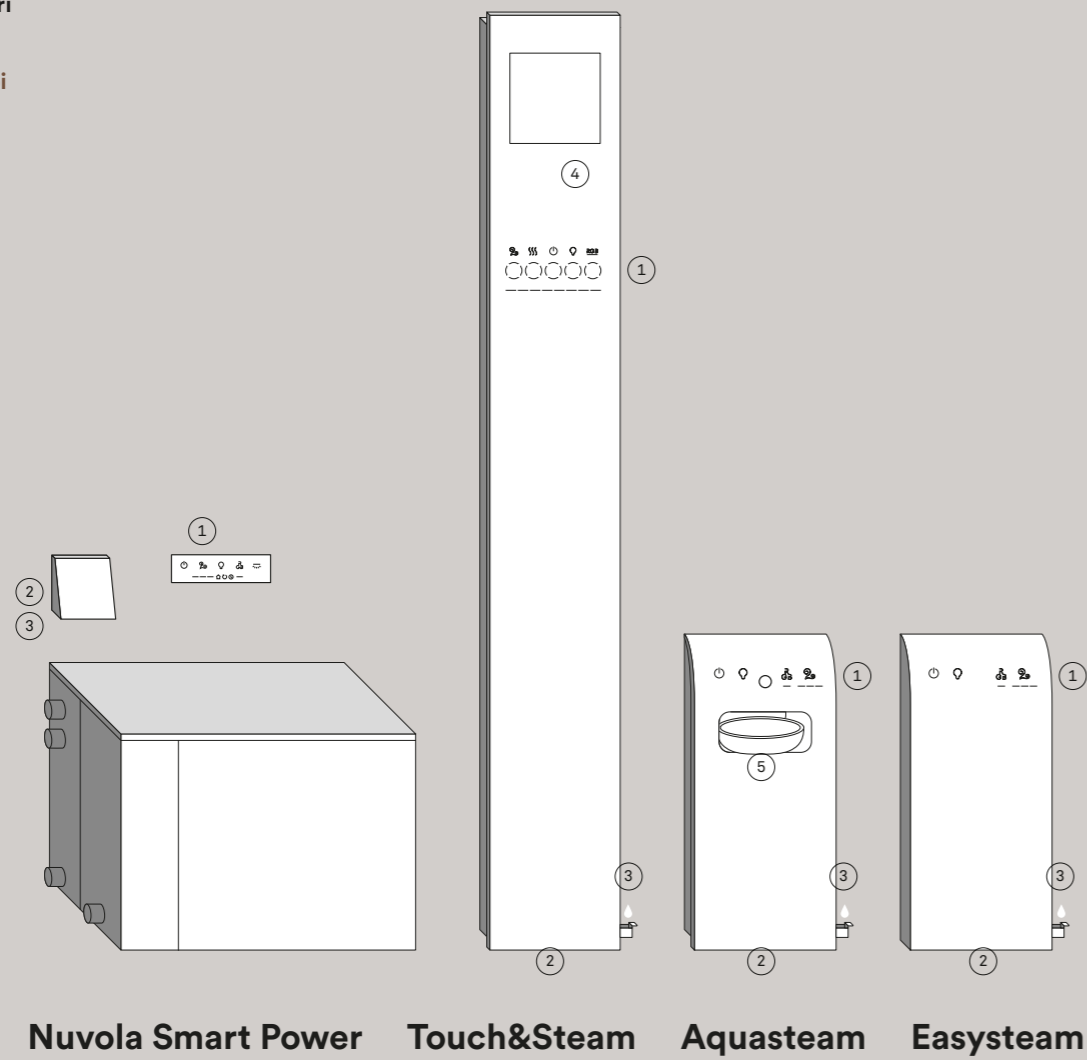

TOUCH CONTROLS	①				
POWER STEAM	②				
RWF - REGULATING WATER FLOW					
SWF - SMART WATER FILLING					
SBC - SMART BOILER CLEANING					
SEC - SMART ENERGY CONTROL					
ODS - OPEN DOOR SENSOR					
ECC - EFFEGIBI COMFORT CONTROL					
AROMATHERAPY	③				
RGB CHROMOTHERAPY	④				
FOUNTAIN	⑤				

Produzione di vapore in relazione al vano hammam

Steam generated in relation to the Hammam cubicle

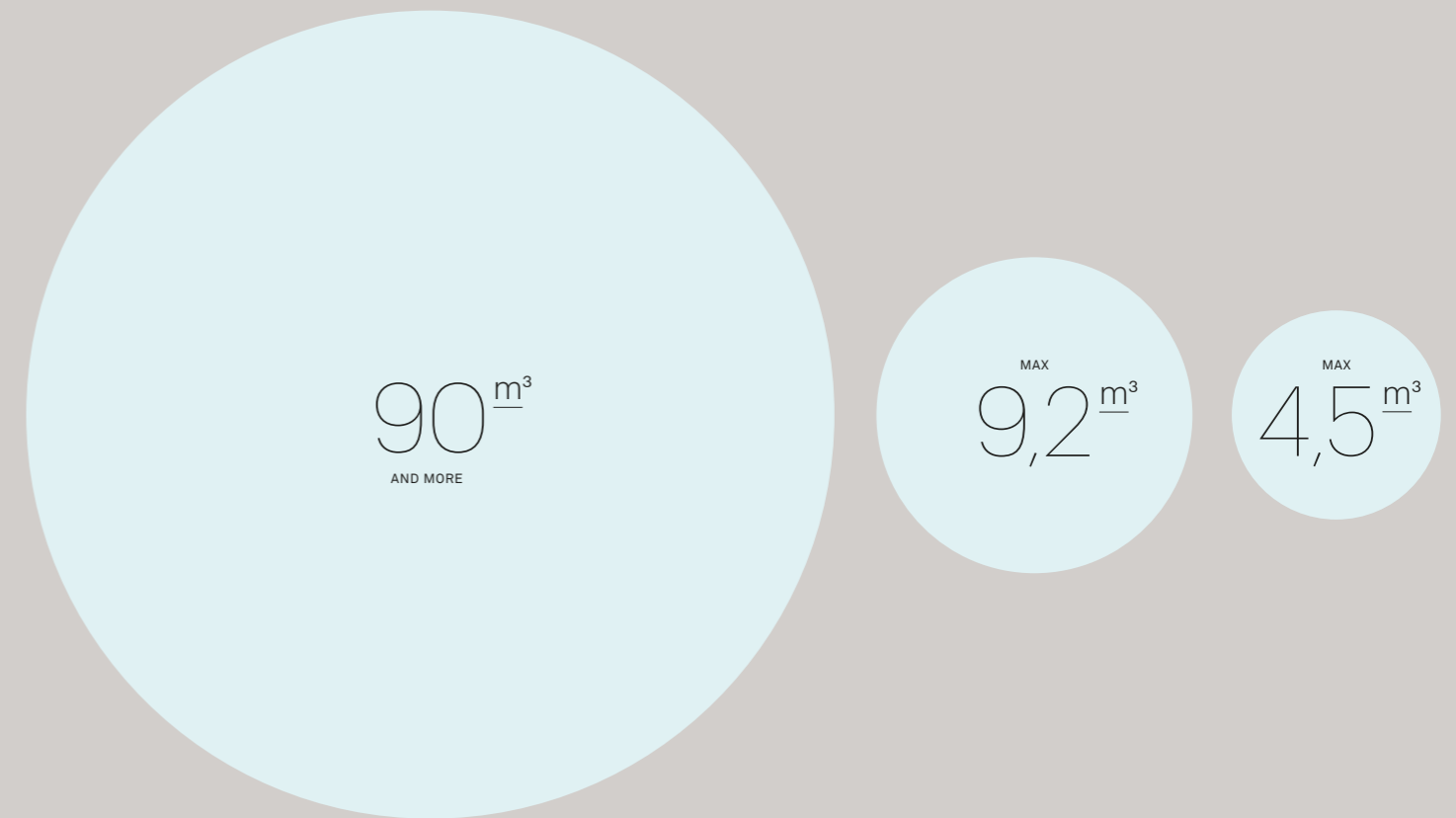

NUVOLA SMART POWER

TOUCH&STEAM

AQUASTEAM / EASYSTEAM

Ogni articolo Effegibi è sottoposto a verifiche qualitative sia sotto l'aspetto estetico che funzionale. La sicurezza dei prodotti Effegibi è certificata a livello internazionale dai principali marchi di qualità che garantiscono il rispetto delle più severe normative vigenti.

All Effegibi products are subject to quality checks in terms of both their aesthetics and functions. The safety of Effegibi products is certified by all the leading international certification bodies to guarantee compliance with the most rigorous current standards.



# Know-how & Technology

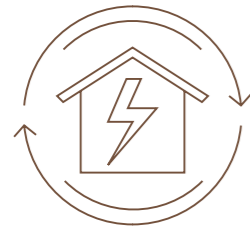

SMART ENERGY CONTROL

## SEC

Distribuzione uniforme nel tempo dei cicli di accensione e spegnimento delle termoresistenze in modo da ottenere una diffusione di vapore costante

Evenly spaced on/off periods for the heating elements to obtain even steam distribution throughout the session

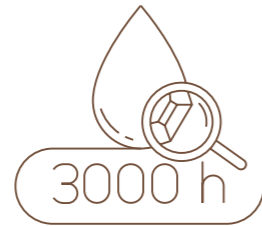

SMART BOILER CLEANING

## SBC

Diluizioni e risciacqui intermedi calcolati sul reale fabbisogno per ridurre l'accumulo di calcare e aumentare la durata della caldaia senza manutenzione

Dilution and intermediate rinsing processes not time controlled but based on real need to reduce limescale deposits and avoid frequent boiler maintenance



SMART WATER FILLING

## SWF

Gestione ottimizzata di riempimento caldaia, risciacqui intermedi e svuotamento. Le resistenze lavorano sempre in maniera ottimale

Optimised management of boiler filling, intermediate rinsing and emptying process. Heating elements programmed for optimum operation

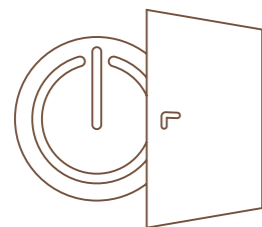

OPEN DOOR SENSOR

## ODS

Grazie alla sofisticata elettronica il generatore comprende quando la porta è aperta e blocca in automatico la produzione del vapore

The sophisticated electronics allow the generator to sense when the door is open and automatically block steam generation



EFFEGIBI COMFORT CONTROL

## ECC

Il sistema è integrato in ogni generatore di vapore Effegibi e consente di gestire a distanza il bagno turco tramite App Effegibi Experience My Hammam su tablet o smartphone

This system is built into every Effegibi steam generator, enabling remote control of the Turkish bath from a tablet or smartphone using the Effegibi Experience My Hammam app



REGULATING WATER FLOW

## RWF

Il generatore può lavorare dentro un ampio range di pressione dell'impianto idrico del locale: da 0,2 bar a 10 bar

The generator can work on a wide range of water systems with different pressures, from 0.2 bar to 10 bar

TRADITIONAL HAMMAM



NEW TECHNOLOGY FROM EFFEGIBI



L'innovativo sistema di gestione della ventilazione minimizza la stratificazione delle temperature all'interno della cabina.

Il controllo delle funzioni hammam nei prodotti Effegibi è gestito da eleganti pannelli Touch retroilluminati, intuitivi e sempre visibili anche in presenza di vapore.

The innovative ventilation management system minimises temperature layering inside the cubicle.

All the functions of Effegibi Hammams are controlled from a stylish back-lit touch panel, that is intuitive to use and can always be seen through the steam.

ON-OFF BUTTON HAMMAM BUTTON WHITE LIGHT BUTTON RGB LIGHT BUTTON MOOD LIGHTING BUTTON

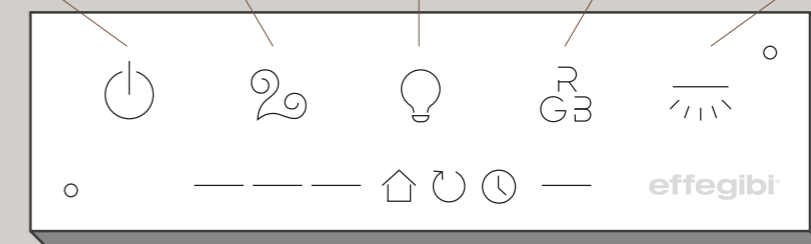

HOME-AUTOMATION ICON

REMOTE ICON

PROGRAMMING ICON



Hotel Rosa Alpina  
Châlet Zeno  
San Cassiano - Bolzano  
Italy





→ Steam generator:  
Nuvola Smart Power.  
Door: Tuttovetro Inside,  
with built-in frame  
(h220cm)



→ Touch&Steam with Spaziofilo 160 door. Topkapi Bench with natural finish Burma teak seat.

# Touch&Steam

STEAM GENERATOR

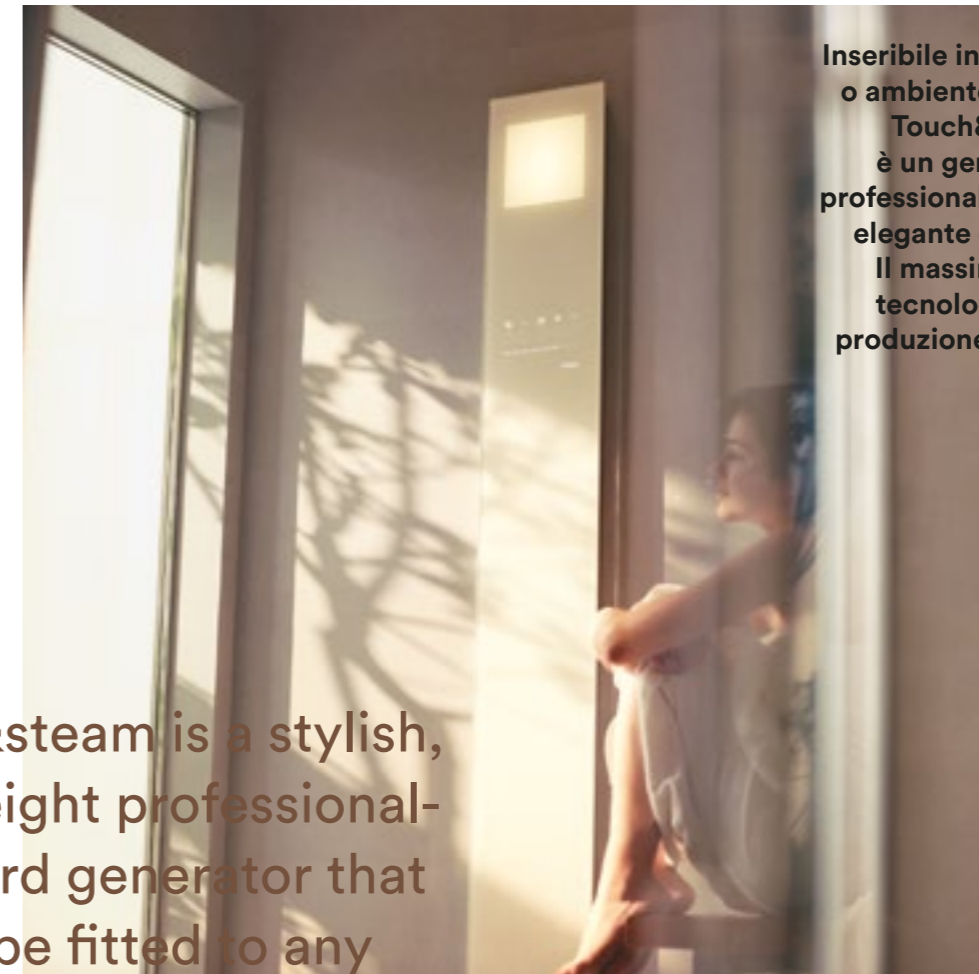

Inseribile in ogni doccia o ambiente hammam Touch&steam è un generatore professionale dal design elegante e leggero. Il massimo della tecnologia nella produzione di vapore.

Touch&steam is a stylish, lightweight professional-standard generator that can be fitted to any shower or Hammam environment. State-of-the-art steam-generating technology.

→ **Generatore di vapore completo di cromoterapia e aromaterapia**  
 → Steam generator complete with colour and aroma therapy

→ **Tecnologia Effegibi per la generazione del vapore: il massimo del controllo su qualità, densità e igiene**  
 → Effegibi steam generation technology gives you maximum control over steam quality and density and hygiene

→ **Sistema ventilazione dell'aria che minimizza la stratificazione delle temperature all'interno della cabina**  
 → Air ventilation system minimises temperature layering inside the cubicle

→ **Manutenzione ridotta grazie al sistema automatico di lavaggio della caldaia che minimizza l'accumulo di calcare**  
 → Low maintenance thanks to the automatic boiler-cleaning system that minimises lime-scale build-up

→ **Pannello di controllo touch con icone retroilluminate e indicatore del livello di temperatura**  
 → Touch-screen control panel with backlit icons and temperature indicator

→ **ESS - Effegibi Sound System, per il controllo della musica direttamente dal proprio dispositivo**  
 → ESS - Effegibi Sound System, delivers music from your own device

→ **Caldo Doccia: sistema di riscaldamento a ventilazione forzata con funzione di preriscaldamento vano**  
 → Warm air function: forced ventilation heating system with unit pre-heating function

→ **Design elegante e compatto costituito da una lastra di vetro temperato serigrafato, spessore visibile: 3,7 cm**  
 → Stylish, compact design featuring a panel of silk-screen-printed toughened glass, visible thickness 3.7cm

→ **Abbinabile alle porte e vetrate della gamma Effegibi, specificamente progettate per hammam**  
 → Can be teamed with doors and glass panels from the Effegibi range specifically designed for Hammams

# Touch&Steam

STEAM GENERATOR

## Dimensioni

**Touch&Steam:**  
 CM 23 X 3,7 X 165 H

## Dimensions

**Touch&Steam:**  
 23 X 3.7 X H165 CM

## Controcassa:

CM 40 X 10 X 173 H

## Counterbox:

40 X 10 X H173 CM

## Volume vano:

MAX 9.2 M<sup>3</sup>

## Cubicle volume:

MAX 9.2 M<sup>3</sup>

MODELLO MODEL	VOLUME VANO COMPARTMENT VOLUME (M <sup>3</sup> )	POTENZA POWER (KW)
30	0 - 3,5	3,0
45	3,5 - 4,5	4,5
60	4,5 - 6,2	6,0
90	6,2 - 9,2	9,0



→ **Touch&Steam with Spaziofilo 160 door and Spaziofilo 80 glass panel.**





## Doors and glass panels

Touch&Steam can be fitted to any environment set up to house a Hammam, from a home shower to larger spaces and also made-to-measure designs. It is essential for such an area to be fitted with doors and glass panels specifically designed for a Hammam, capable of insulating it from the outer environment while maintaining a controlled air-flow.

## Porte e vetrate

Touch&Steam può essere applicato in ogni ambiente predisposto per ospitare un hammam: dalla doccia di casa a spazi più ampi, anche progettati su misura. È fondamentale che a queste aree siano applicate porte e vetrate specifiche per hammam, in grado di isolare dall'esterno mantenendo un passaggio calibrato dell'aria.



With Touch&Steam you can enjoy the benefits of colour therapy. There is a choice of five fixed colours (red, yellow, green, blue, aquamarine) and 4 programs providing tonal variations within one colour range (dawn, sunset, sea, forest).

Con Touch&Steam si apprezzano i benefici della cromoterapia. Si può scegliere tra 5 colori in modalità fissa (rosso, giallo, verde, blu, acquamarina) e 4 programmi di variazioni di una gamma cromatica (alba, tramonto, mare, bosco).

→ Touch&Steam with Spaziofilo 160 door and Spaziofilo 80 glass panel.



Hotel Rosa Alpina  
Châlet Zeno  
San Cassiano - Italy







TRANSFORM  
YOUR SHOWER  
INTO  
A HAMMAM

TRASFORMA  
LA TUA DOCCIA  
IN HAMMAM

The secret to creating your dream Turkish bath at home is perfect door insulation to ensure that the steam stays inside while the right amount of air flows in from outside. Effegibi has designed a range of professional-standard doors that can be fitted to your shower cubicle to keep steam density constant and reduce consumption.

Il segreto per realizzare il bagno turco ideale a casa propria è l'utilizzo di una perfetta coibentazione della porta, in modo che il vapore sia isolato all'interno, mentre viene garantito il giusto ingresso di aria dall'esterno. Effegibi ha studiato una serie di porte professionali da applicare alla cabina doccia, per mantenere costante la densità del vapore e ridurre i consumi.

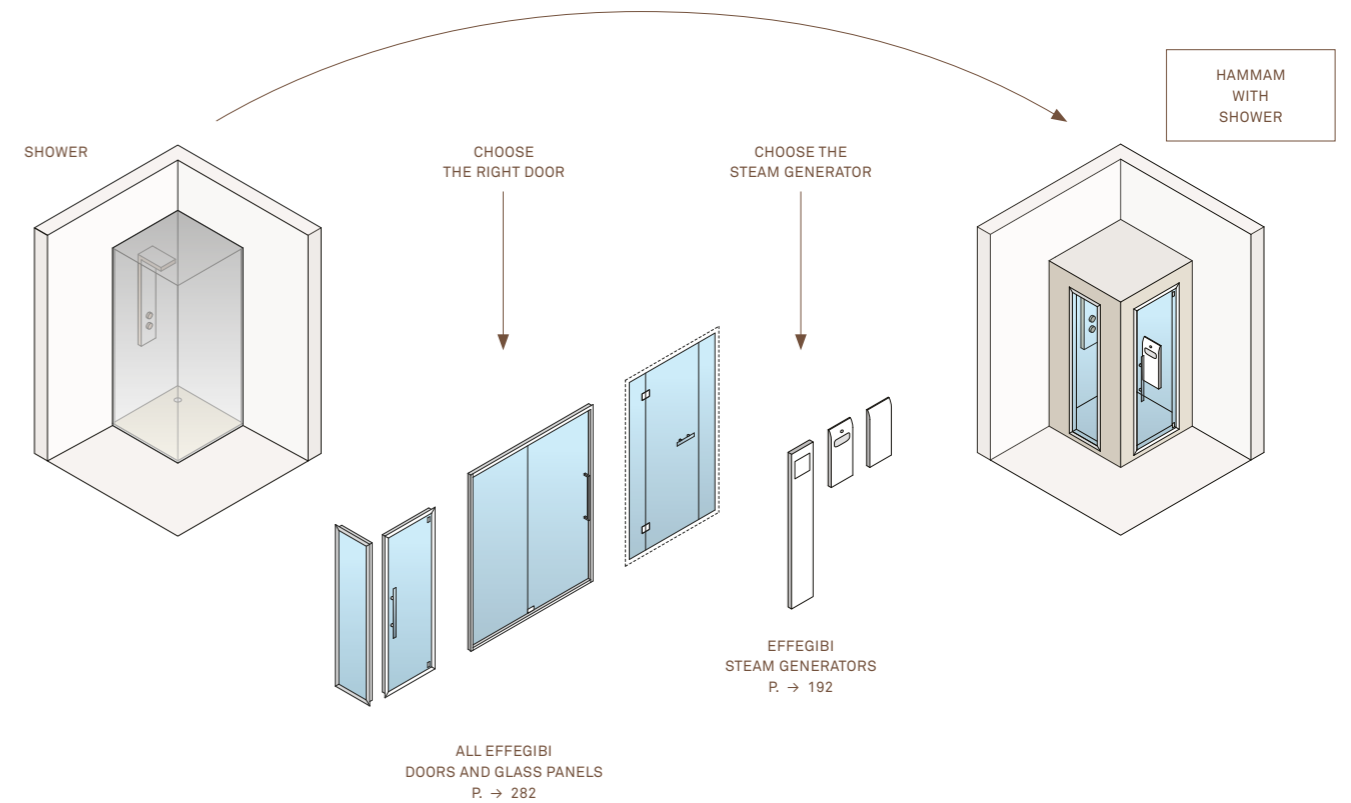



# Aquasteam

STEAM GENERATOR

Una lastra di vetro curvato con comandi digitali, una fonte e una ciotola rendono Aquasteam un generatore di vapore intuitivo nell'uso e perfettamente abbinabile a qualsiasi rivestimento.

A curved glass panel with digital controls, a spring and a bowl make Aquasteam an intuitive steam generator to use that blends perfectly with any décor.

→ Generatore di vapore con fonte, ciotola, aromaterapia  
 → Steam generator with spring, bowl and aroma therapy

→ Tecnologia Effegibi per la generazione del vapore: igiene, controllo del calcare e massima qualità del vapore  
 → Effegibi steam generation technology gives you maximum control over hygiene, lime-scale build-up and steam quality

→ Manutenzione ridotta e lunga durata grazie al sistema automatico di lavaggio della caldaia  
 → Low maintenance and a long life thanks to the automatic boiler-cleaning system

→ Design molto compatto costituito da una lastra di vetro curvato serigrafato, spessore visibile: 3,7 cm  
 → Extremely compact design featuring a curved panel of silk-screen-printed glass, visible thickness 3.7cm

→ Pannello di controllo touch con icone retroilluminate e indicatore del livello di temperatura  
 → Touch-screen control panel with backlit icons and temperature indicator

→ Predisposizione per collegamento a lampada per cromoterapia  
 → Set up for connection to a colour therapy lamp

→ Abbinabile alle porte e vetrate della gamma Effegibi, specificamente progettate per hammam  
 → Can be teamed with doors and glass panels from the Effegibi range specifically designed for Hammams

# Aquasteam

STEAM GENERATOR

**Dimensioni**  
**Aquasteam:**  
 CM 25 X 3,7 X 57 H

**Dimensions**  
**Aquasteam:**  
 25 X 3.7 X H57 CM

**Controcassa:**  
 CM 37 X 10 X 54 H

**Counterbox:**  
 37 X 10 X H54 CM

**Volume vano:**  
 MAX 4,5 M<sup>3</sup>

**Cubicle volume:**  
 MAX 4.5 M<sup>3</sup>

MODELLO MODEL	VOLUME VANO COMPARTMENT VOLUME (M <sup>3</sup> )	POTENZA POWER (KW)
30	0 - 3,5	3,0
45	3,5 - 4,5	4,5



→ Aquasteam with Spazio 80 door

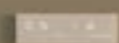

→ Aquasteam  
with Spazio 80  
door



Aquasteam è dotato di una fonte di acqua fresca attivabile con un pratico comando touch.

Il cassetto porta essenze situato in basso permetterà la diffusione della vostra scelta di aromi.

Aquasteam is equipped with a cool water spring operated by a practical touch-screen control.

The holder for essential oils at the bottom allows you to recreate your favourite aroma therapy experience.

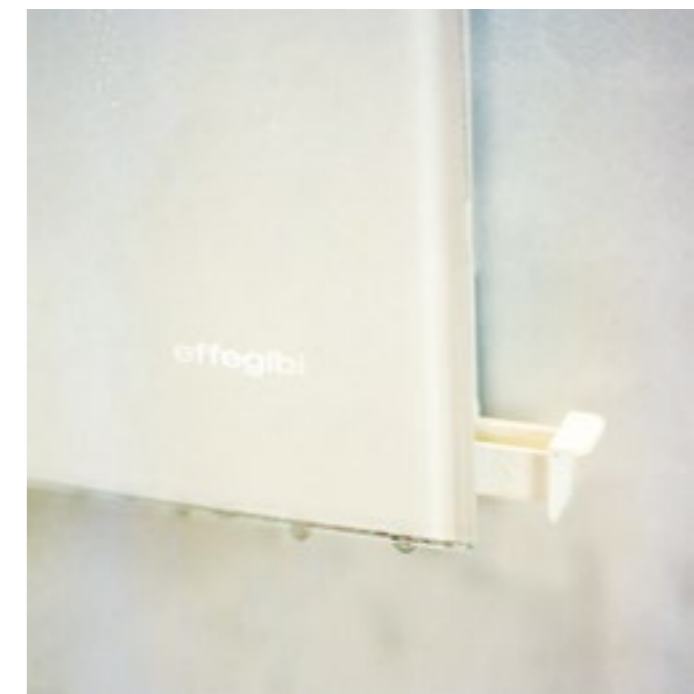



# Easystem

STEAM GENERATOR

A stylish, compact steam generator, Easystem is easy to install, high-tech and user-friendly.

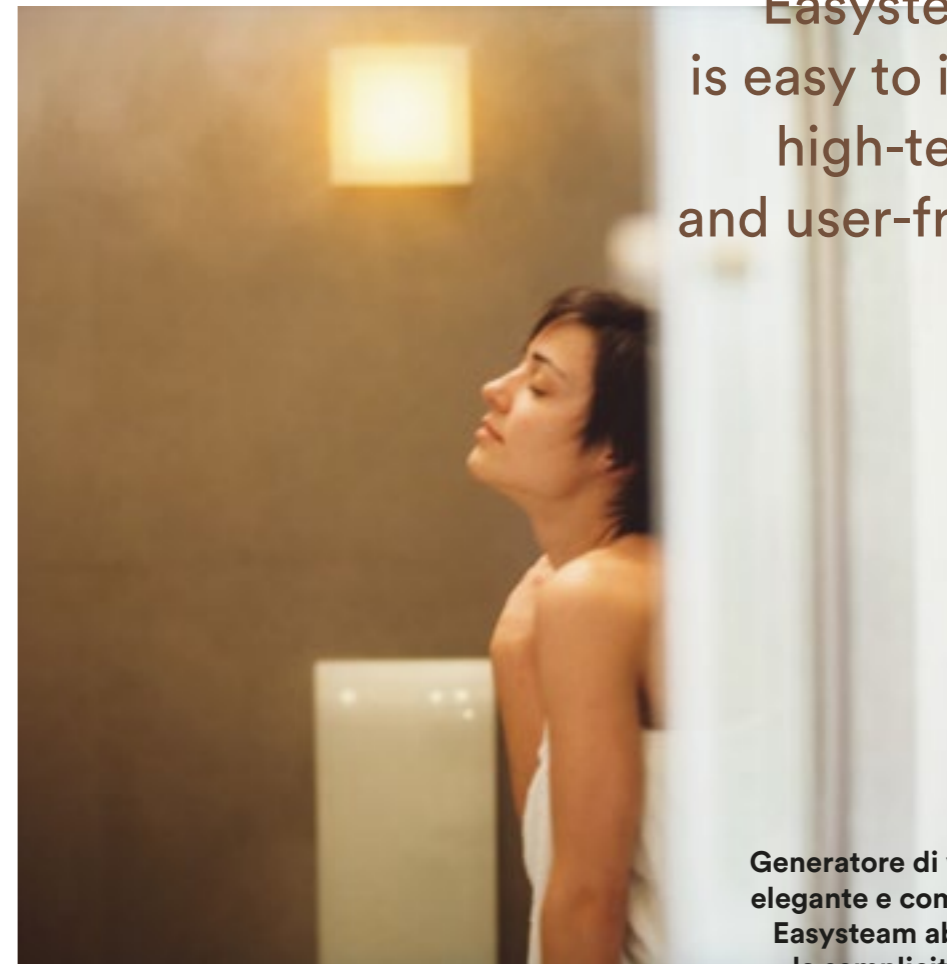

**Generatore di vapore elegante e compatto, Easystem abbina la semplicità di installazione, elevata tecnologia e semplicità di utilizzo.**

→ Generatore di vapore con aromaterapia  
→ Steam generator with aroma therapy

→ Tecnologia Effegibi per la generazione del vapore: igiene, controllo del calcare e massima qualità del vapore  
→ Effegibi steam generation technology gives you maximum control over hygiene, lime-scale build-up and steam quality

→ Manutenzione ridotta e lunga durata grazie al sistema automatico di lavaggio della caldaia  
→ Low maintenance and a long life thanks to the automatic boiler-cleaning system

→ Design molto compatto costituito da una lastra di vetro curvato serigrafato, spessore visibile: 3,7 cm  
→ Extremely compact design featuring a curved panel of silk-screen-printed glass, visible thickness 3.7cm

→ Pannello di controllo touch con icone retroilluminate e indicatore del livello di temperatura  
→ Touch-screen control panel with backlit icons and temperature indicator

→ Predisposizione per collegamento a lampada per cromoterapia  
→ Set up for connection to a colour therapy lamp

→ Abbinabile alle porte e vetrate della gamma Effegibi, specificamente progettate per hammam  
→ Can be teamed with doors and glass panels from the Effegibi range specifically designed for Hammams

# Easystem

STEAM GENERATOR

## Dimensioni

Easystem:  
CM 25 X 3,7 X 57 H

Controcassa:  
CM 37 X 10 X 54 H

## Dimensions

Easystem:  
25 X 3.7 X H57 CM

Counterbox:  
37 X 10 X H54 CM

MODELLO MODEL	VOLUME VANO COMPARTMENT VOLUME (M <sup>3</sup> )	POTENZA POWER (KW)
30	0 - 3,5	3,0
45	3,5 - 4,5	4,5



→ Easystem with Smart 65 door



→ Easystem  
with Smart 65  
door

→ Come tutti i prodotti della famiglia touch Easystem è dotato di contenitore porta essenze laterale per una inebriante esperienza di aromaterapia.

→ L'aromaterapia è stata riconosciuta per secoli come avente effetti curativi. Gli oli essenziali utilizzati nell'hammam possono aiutare a svegliare, rinfrescare, stimolare, rilassare il corpo e la mente.

→ Just like all the products in the touch control family, Easystem has a container for essential oils at the side, for an inebriant aroma-therapy experience.

→ The curative effects of aroma therapy have been recognised for centuries. Using essential oils in your Hammam can help to wake up, refresh, stimulate and relax your body and mind.



**Generatore di vapore disponibile in versione 3 e 4,5 kW. Una lastra di vetro curvato rappresenta l'interfaccia di comando con icone retroilluminate.**

Steam generator available in 3 and 4.5 kW versions. A curved glass panel forms the control interface with backlit icons.



# Nuvola Smart Power

STEAM GENERATOR

Generatore di vapore ad alta potenza, da collocare all'esterno dello spazio hammam: la più sofisticata tecnologia esistente e la pulizia formale fanno Nuvola Smart Power un prodotto senza rivali.

A high-power steam generator, to be fitted outside the Hammam space. The most sophisticated technology in existence and its clean lines make Nuvola Smart Power an unrivalled product.

→ Generatore di vapore professionale esterno, adatto per ampie cubature  
 → External professional-standard steam generator suitable for large spaces

→ 3000 ore garantite di funzionamento senza bisogno di manutenzione  
 → 3000 hours maintenance-free operation guaranteed

→ Vapore e temperatura sempre perfetti grazie al nuovo Sistema ventilazione dell'aria  
 → Perfect steam and temperature guaranteed every time by the new air ventilation system

→ Funzione ODS (Open Door Sensor): il generatore blocca la produzione di vapore se rileva che la porta è aperta  
 → ODS (Open Door Sensor) function stops the generator producing steam if the sensor detects that the door is open

→ Nuvola Smart Power è adatto per soluzioni ad incasso e consente quindi l'applicazione a spazi realizzati su misura  
 → Nuvola Smart Power is ideal for built-in solutions making it suitable for made-to-measure spaces

→ Controllo automatico delle termoresistenze per una distribuzione di vapore uniforme nel tempo  
 → Automatic heating element control for even steam distribution over time

→ Pannello di controllo touch con icone retroilluminate e indicatore del livello di temperatura  
 → Touch-screen control panel with backlit icons and temperature indicator

→ Funzione SWF (Smart Water Filling): gestione ottimizzata di utilizzo della caldaia per il massimo risparmio energetico e aumento della durata  
 → SWF (Smart Water Filling) function optimises boiler use for maximum energy saving and increased longevity

# Nuvola Smart Power

STEAM GENERATOR

Dimensioni:  
 CM 52 X 26 X 27 H

Dimensions:  
 52 X 26 X H27 CM

Volume vano:  
 50 M<sup>3</sup> E OLTRE

Cubicle volume:  
 50 M<sup>3</sup> AND ABOVE

MODELLO MODEL	VOLUME VANO COMPARTMENT VOLUME (M <sup>3</sup> )	POTENZA POWER (KW)
25	0 - 2,5	2,5
30	2,5 - 3,5	3,0
45	3,5 - 4,5	4,5
55	4,5 - 5,5	5,5
70	5,5 - 7,2	7,0
90	7,2 - 9,2	9,0
110	9,2 - 12,0	11,0
140	12,0 - 15,0	14,0
180	15,0 - 25,0	18,0
250	25,0 - 35,0	25,0
360	35,0 - 50,0	36,0

## Diffusore di vapore

Nuvola Smart Power è dotato di un nuovo diffusore ad altissima tecnologia completo di ventilazione per mantenere sempre uniforme la densità e la temperatura del vapore

## Steam Diffuser

Nuvola Smart Power is equipped with a new high-tech steam diffuser with ventilation to keep the steam density and temperature even





→ Nuvola Smart Power  
with Tuttovetro  
Inside door with built-in  
frame (h220cm)

→ Nuvola Smart Power  
è disponibile con potenze da 2,5  
a 36 kw, per spazi fino a 50 m<sup>3</sup>.  
Per ambienti di maggiore  
dimensione è possibile rivolgersi  
a Effegibi per studiare soluzioni  
personalizzate.

→ Nuvola Smart Power  
is available in 2.5 to 36 kw  
versions for spaces up to 50 m<sup>3</sup>.  
For larger environments you  
can call on the Effegibi team  
to come up with personalised  
solutions.





→ **Coordinated**  
FeelGood shower system  
teamed with Nuvola Smart  
Power. Touch-screen control  
panel with backlit icons  
operates all the functions  
(shower, steam, lighting).  
FeelGood can be teamed with  
any Effegibi steam generator.

→ **Sistema coordinato**  
doccia FeelGood abbinato  
a Nuvola Smart Power.  
Pannello di controllo touch  
con icone retroilluminate per  
la gestione di tutte le funzioni  
(doccia, vapore, luce)  
FeelGood può essere abbinato  
a qualsiasi generatore di vapore  
Effegibi.





Effegibi can produce made-to-measure designs able to combine saunas, Hammams, relaxation zones and a shower area, in other words, the perfect spa.

Effegibi è in grado di realizzare progetti su misura che prevedono la combinazione di saune, hammam, spazi relax, area doccia: il centro benessere ideale.

→ Nuvola Smart Power with Tuttovetro Inside door with built-in frame (h220cm)



→ **Porta Tuttovetro Inside profilo incassato:** sistema componibile di porte che permette di coprire ampie superfici vetrate mantenendo la massima eleganza e leggerezza nei profili

→ **Tuttovetro Inside door with built-in frame:** a system for building doors making it possible to cover large glass surfaces while maintaining the stylish, lightweight look of the frame.

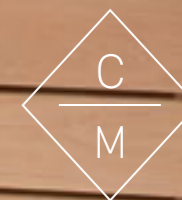

EFFEGIBI CUSTOM MADE



→ Touch-screen control panel with backlit icons and temperature indicator



→ Tuttovetro Inside door with built-in frame

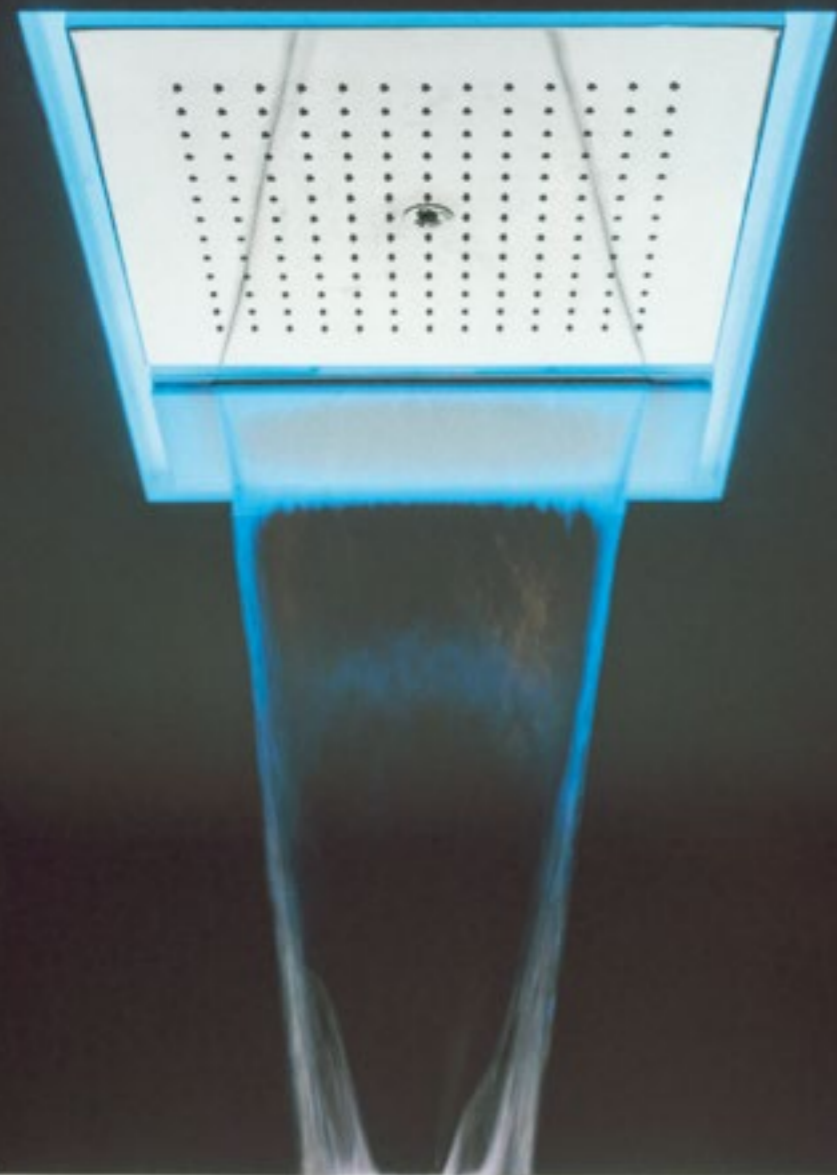

# FeelGood

SHOWER SYSTEM

An elegant coordinated collection for your personal spa: Turkish bath, multifunctional shower and colour therapy all operated by the high-tech Effegibi touch control panel.

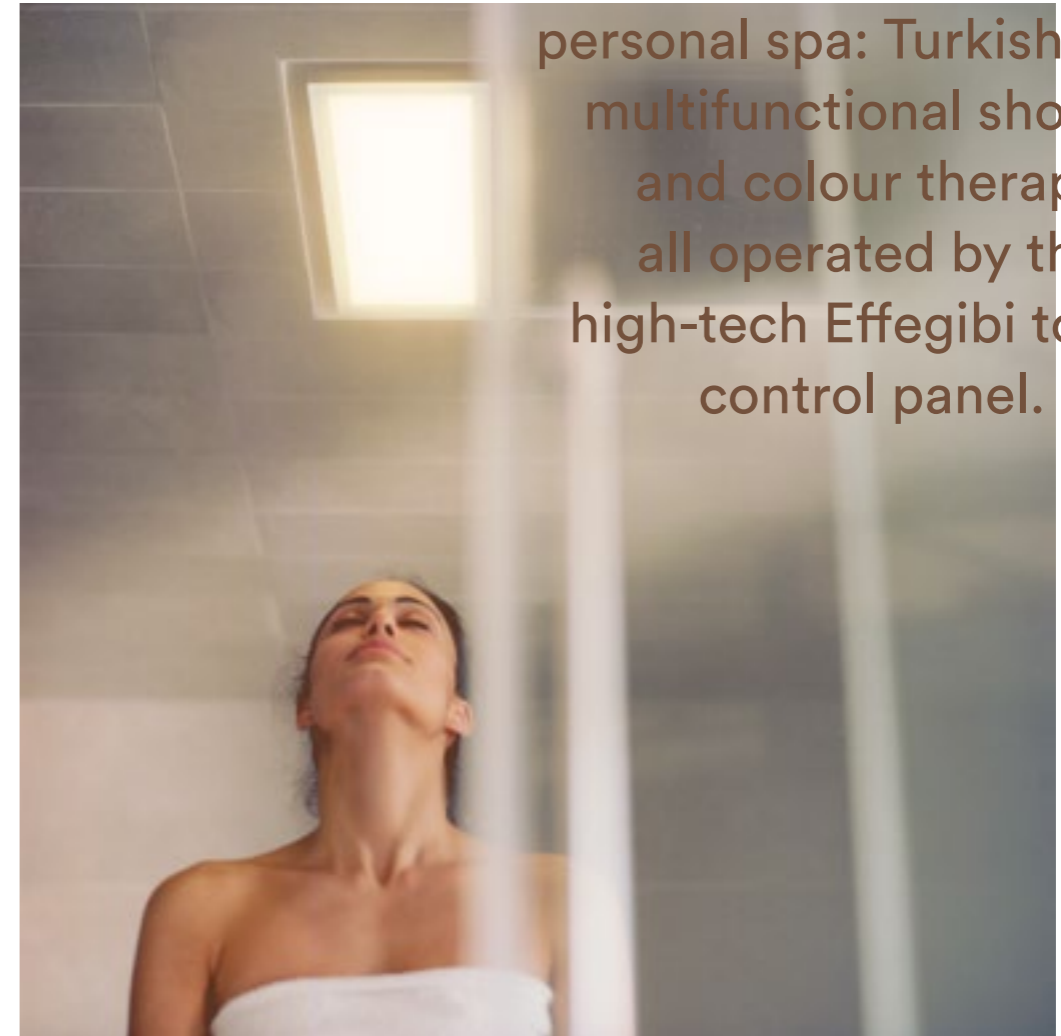

**Elegante collezione coordinata per il vostro spazio benessere: bagno turco, doccia multifunzionale e cromoterapia, tutto gestito dal pannello di controllo touch Effegibi ad alta tecnologia.**

→ Sistema coordinato per spazio doccia con generatore di vapore e doccia multifunzione  
 → A coordinated system for a shower space with steam generator and multifunctional shower

→ FeelGood può essere abbinato a qualsiasi generatore di vapore Effegibi  
 → FeelGood can be teamed with any Effegibi steam generator

→ Pannello di controllo touch con icone retroilluminate per la gestione di tutte le funzioni (doccia, vapore, luce)  
 → Touch-screen control panel with backlit icons operates all the functions (shower, steam, lighting)

→ Doccia con tre differenti getti d'acqua: acqua a pioggia, a cascata e nebulizzata

→ Shower with three different flows of water: rain, waterfall and mist

→ FeelGood può essere installato facilmente su ambienti realizzati su misura  
 → FeelGood is easy to install in made-to-measure environments

# FeelGood

SHOWER SYSTEM

Dimensioni soffione:  
 CM 47 X 67

Shower head dimensions:  
 CM 47 X 67



→ Coordinated shower system for Hammam teamed with a Touch&Steam steam generator

→ Spazioslide 160 door and Spazio 80 glass panel



→ **Made-to-measure  
Hammam space with  
FeelGood, Touch&steam  
steam generator  
and Spazioslide 160 door**



Coordinated shower system for Hammam.  
Shower with three different flows of water:  
rain, waterfall and mist

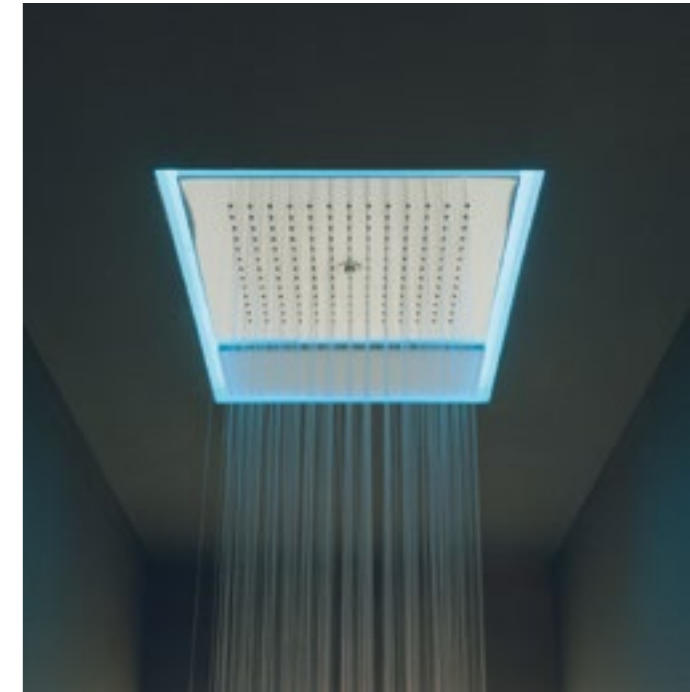



→ FeelGood with  
Touch&Steam steam  
generator  
and Spazioslide 160 door



→ Touch-screen  
control panel with backlit  
icons operates all the  
functions





→ FeelGood  
is easy to install  
in made-to-measure  
environments

## Come si fa il bagno turco

Il grande bisogno di relax e tranquillità tipico della nostra civiltà si scioglie nel caldo tepore dell'hammam.

Non esiste un momento giusto per farlo, la scelta è molto personale. È preferibile, però, seguire alcuni suggerimenti. Prima di entrare è meglio bere un bicchiere d'acqua o una tisana, per evitare di disidratarsi. Poi, inumidire la pelle con una doccia tiepida per prepararla al bagno di vapore.

Nel bagno turco si può stare nudi o coperti da un asciugamano in fibra naturale. Il periodo di permanenza varia da 10 a 15 minuti, ma occorre ascoltare il proprio corpo e fermarsi fino a quando non si desidera uscire.

## How to take a Turkish bath

That great yearning for peace and relaxation so typical of our society dissolves in the warmth of the Hammam.

There is no one right time to take a Turkish bath, this is an entirely personal choice, but here is some useful advice. Before entering it is a good idea to drink a glass of water or herbal tea to avoid becoming dehydrated. Then wet your skin with a warm shower to prepare it for the steam bath.

You can enjoy the Turkish bath in the nude or covered with natural fibre towel. You can stay in it for from 10 to 15 minutes but you should listen to your body and stay there until it tells you it's time to leave.

All'interno, oltre al vapore, si può godere anche dell'aromaterapia, con oli essenziali scelti per risvegliare, rinfrescare, stimolare o rilassare. Anche i colori della cromoterapia agiscono beneficamente sul corpo e la mente. Si conclude con una doccia fresca e ci si sdraia per qualche minuto di relax.

In addition to the steam you can also enjoy some aromatherapy with the essential oils of your choice to wake you up, refresh or stimulate yourself or relax. You can also enjoy the physical and mental benefits of colour therapy. Finish your session with a cool shower and lie down and relax for a few minutes.

## How to take a Turkish bath

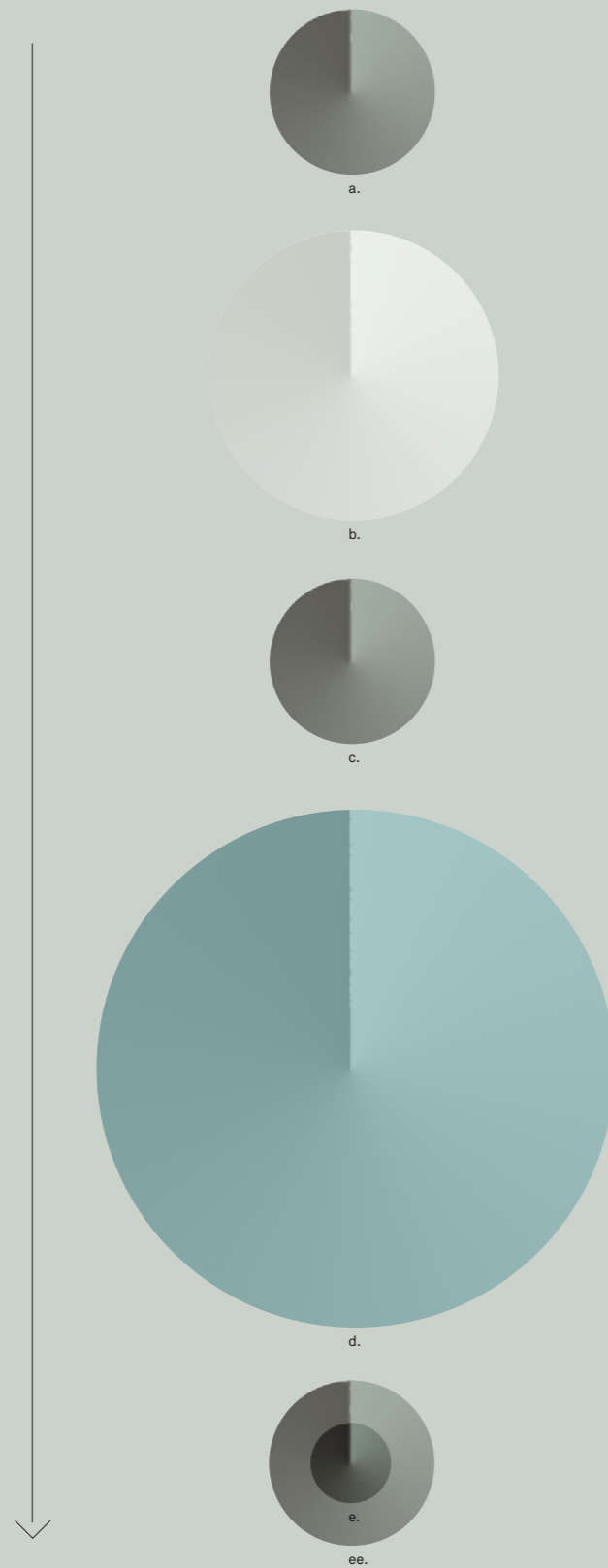

- a. (2')  
Doccia tiepida  
Warm shower
- b. (6')  
Bere tisana calda per favorire la sudorazione  
Drink a hot herbal tea to encourage sweating
- c. (2')  
Frizione con guanto di crine per stimolare la circolazione  
Rub the skin with a horsehair glove to stimulate the circulation
- d. (20')  
Bagno turco  
Turkish bath
- e. (30'')  
Immersione in vasca fredda oppure  
Take a cool bath or  
ee. (2')  
Doccia fredda  
Cool shower

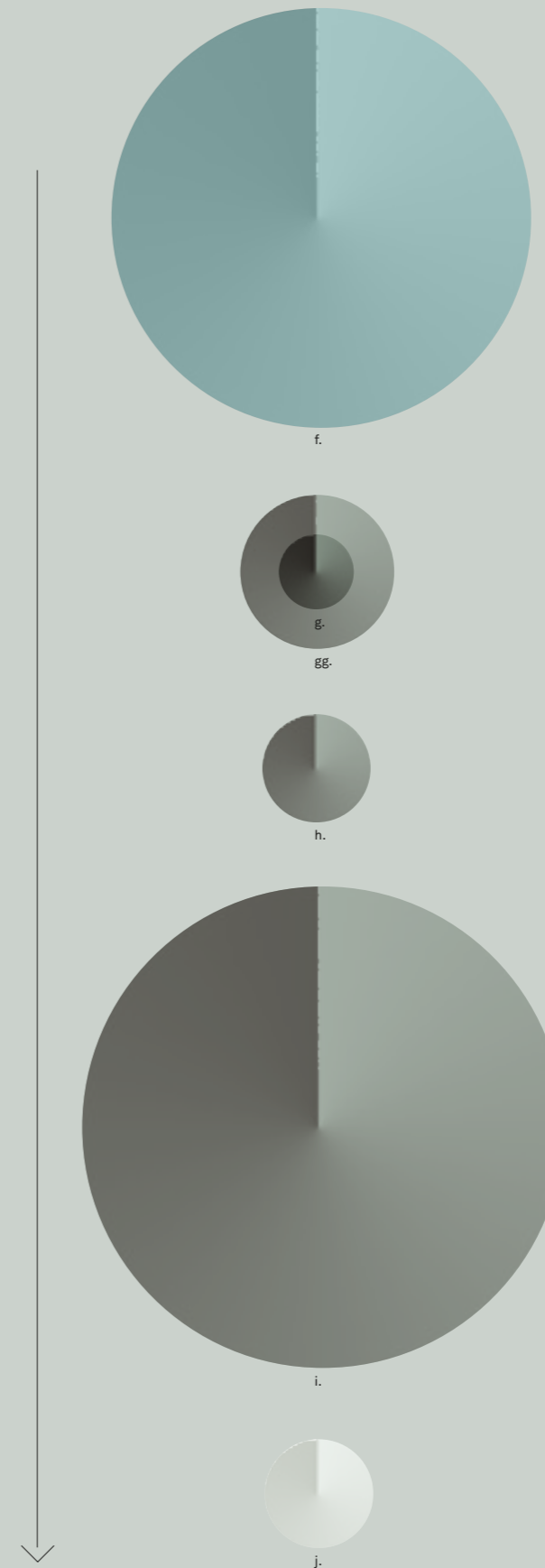

- f. (15')  
Bagno turco  
Turkish bath
- g. (30'')  
Immersione in vasca fredda oppure  
Take a cool bath or  
gg. (2')  
Doccia fredda  
Cool shower
- h. (1')  
Asciugarsi  
Dry yourself
- i. (20')  
Sdraiarsi nel lettino e rilassarsi  
Stretch out and relax on the lounge
- j. (1')  
Bere per reintegrare i liquidi  
Have a drink to restore your liquid balance



EFFEGIBI CUSTOM MADE

Private house  
Saint Petersburg  
Russian Federation

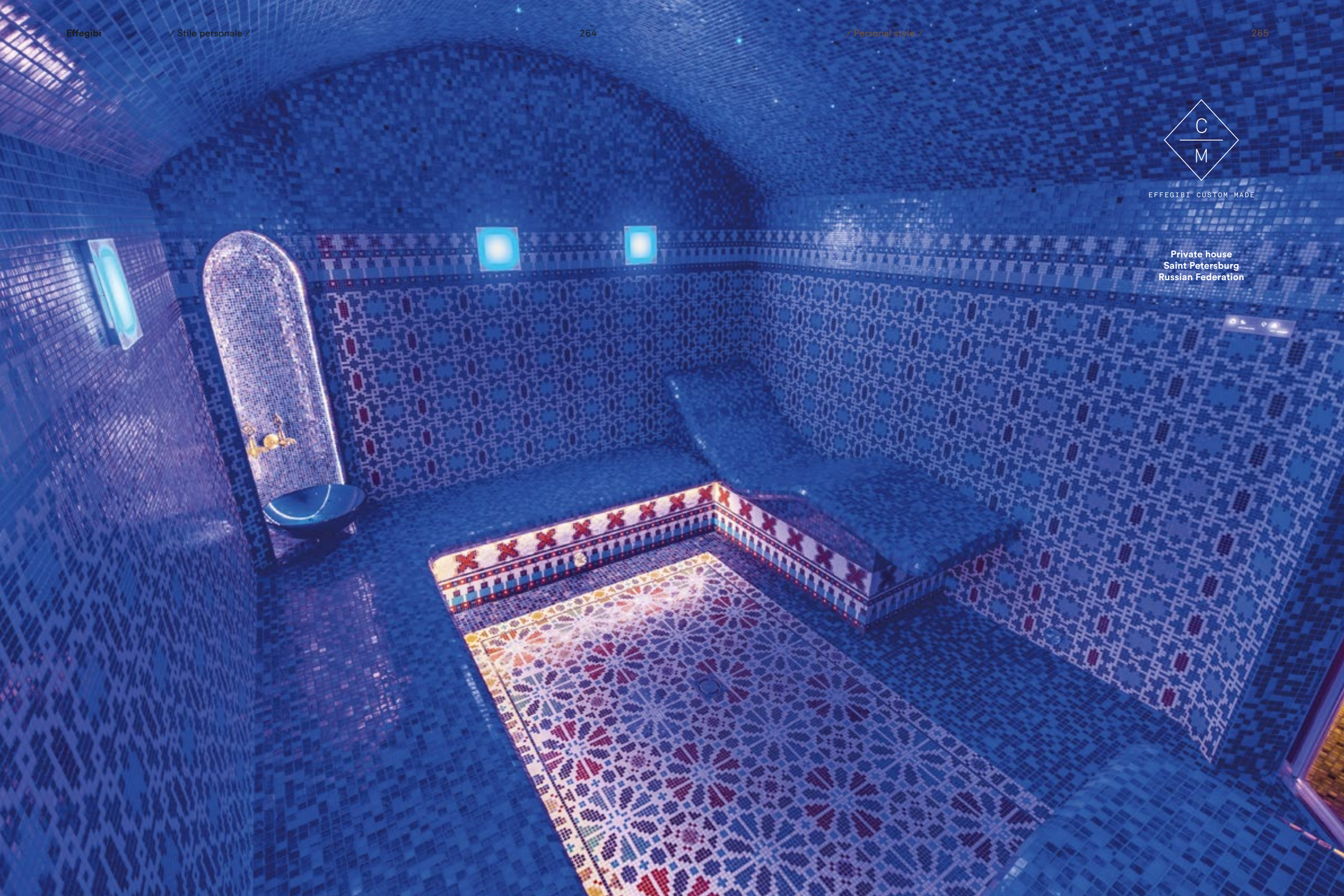

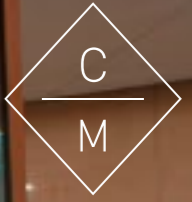

EFFEGIBI CUSTOM MADE

Relaxation Area  
Britannia  
P&O Cruises



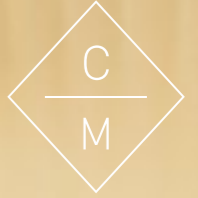

EFFEGIBI CUSTOM MADE

Private house  
Genova  
Italy

→ Omniasteam Touch abbina design, tecnologia, facilità di installazione e si adatta alle diverse esigenze

→ Omniasteam Touch combines design flair, technology and ease of installation, able to meet many different needs

→ Disponibile in due versioni: porta e colonna (88x198 cm) oppure porta, colonna e vetrata fissa (145x198 cm)

→ Available in two versions: door and column (88 x 198cm) or door, column and fixed glass panel (145 x 198cm)

→ Pannello di controllo touch con icone retroilluminate per la gestione di tutte le funzioni

→ Touch-screen control panel with backlit icons to operate all the functions

→ Funzione Caldo doccia: sistema di riscaldamento a ventilazione forzata con funzione preriscaldamento

→ Warm air function: forced ventilation heating system with unit pre-heating function

→ Funzione Power steam: sistema ventilazione dell'aria che minimizza la stratificazione delle temperature all'interno della cabina

→ Power steam function: air ventilation system that minimises temperature layering inside the cubicle

# Omniasteam Touch

DOOR WITH BUILT-IN STEAM GENERATOR

## Dimensioni

Omniasteam Touch 88:  
CM 88 X 198 H

## Dimensions

Omniasteam Touch 88:  
88 X H198 CM

Omniasteam Touch 145:  
CM 145 X 198 H

Omniasteam Touch 145:  
145 X H198 CM

MODELLO MODEL	VOLUME VANO COMPARTMENT VOLUME (M <sup>3</sup> )	POTENZA POWER (KW)
30	0 - 3,5	3,0
45	3,5 - 4,5	4,5

→ Omniasteam Touch 88 with Omnia 70 glass panel







Complete your shower  
with an Omniasteam  
Touch door.  
A column built into the  
frame encloses the steam  
generator and all its  
functions to create your  
personal home Hammam.

→ Omniasteam  
Touch 145  
complete with side  
glass panel



Completa la tua doccia  
con una porta  
Omniasteam Touch:  
una colonna inserita nel  
telaio racchiude il generatore  
di vapore e tutte le funzioni  
per creare in casa  
il tuo hammam personale.

# Steambox

Steambox è il geniale sistema di costruzione del box hammam che consente un velocissimo assemblaggio delle pareti ed è predisposto per un isolamento perfetto dall'esterno, per il mantenimento ottimale di temperatura e qualità del vapore. Steambox è un kit comprensivo di pannelli di polistirene di vario spessore (10 cm e 5 cm) con rete e rasatura cementizia, piatto doccia con scarico integrato e tetto con sezione inclinata. Sono inclusi tutti i materiali necessari all'incollaggio e all'impermeabilizzazione. Il box è rivestibile con piastrelle o mosaico a scelta del cliente, è disponibile in varie configurazioni e consente la facile applicazione dei generatori di vapore e delle porte Spazio Frameless, studiate appositamente.

Steambox is an ingenious construction system for the Hammam cubicle with ultra-quick assembly of the walls and designed for perfect insulation from the outside environment, for optimum temperature control and steam quality. Steambox is a kit including polystyrene panels in two thicknesses, 10cm and 5cm, mesh-reinforced and mortar-finished, complete with shower tray with pre-fitted drain and roof with a sloping section. The kit contains all the necessary adhesives and waterproofing materials. The cubicle can be covered with the tiles or mosaic of the customer's choice and it is available in various formats, making it simple to install the steam generators and specially designed Spazio Frameless doors.

LEARN MORE ABOUT STEAMBOX:

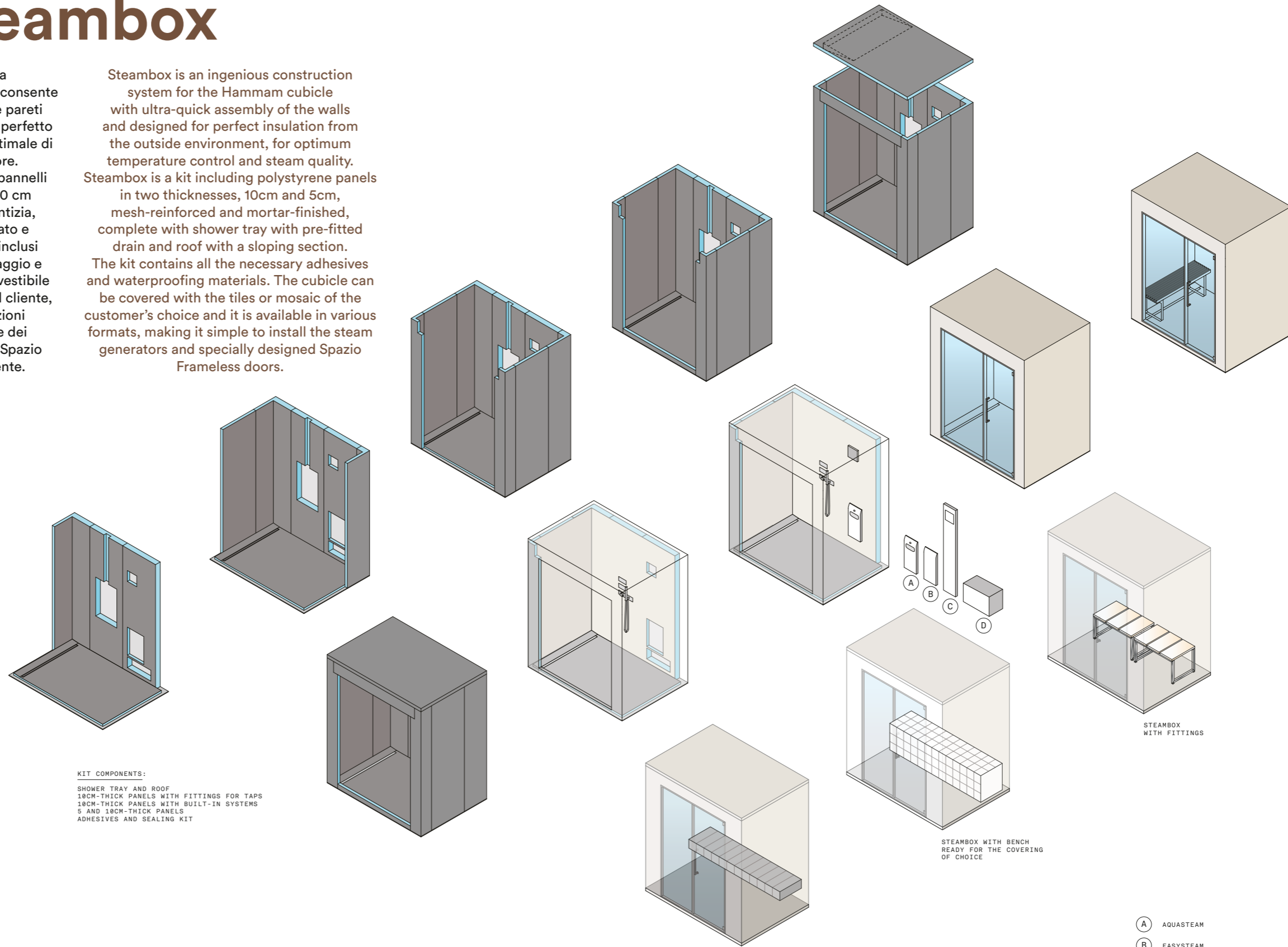

**KIT COMPONENTS:**  
 SHOWER TRAY AND ROOF  
 10CM-THICK PANELS WITH FITTINGS FOR TAPS  
 10CM-THICK PANELS WITH BUILT-IN SYSTEMS  
 5 AND 10CM-THICK PANELS  
 ADHESIVES AND SEALING KIT

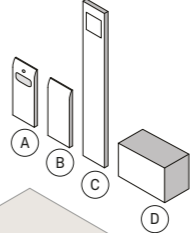

STEAMBOX WITH FITTINGS

STEAMBOX WITH BENCH READY FOR THE COVERING OF CHOICE

STEAMBOX WITH WALL-FITTED BENCH READY FOR THE COVERING OF CHOICE

- (A) AQUASTEAM
- (B) EASYSTEAM
- (C) TOUCH&STEAM
- (D) NUVOLA SMART POWER

# Complementi

# Accessories

# ESS

EFFEGIBI SOUND SYSTEM

Collegando un tablet o uno smartphone alla docking station Effegibi è possibile ascoltare la musica preferita all'interno della sauna, dell'hammam o nell'ambiente in cui si trova. La diffusione all'interno della sauna o dell'hammam avviene tramite un altoparlante posizionato all'interno della cabina.

La docking station, dotata di due casse stereo, si collega automaticamente all'altoparlante interno senza dover installare software o predisporre collegamenti specifici.

The Effegibi docking station can be connected to any tablet or smartphone so you can listen to your favourite music both inside and outside the sauna or the Hammam.

The sound inside the sauna or the Hammam is transmitted by a loudspeaker placed inside the cubicle.

The docking station, which has two stereo speakers, connects automatically to the internal speaker with no need to install any software or make special connections.

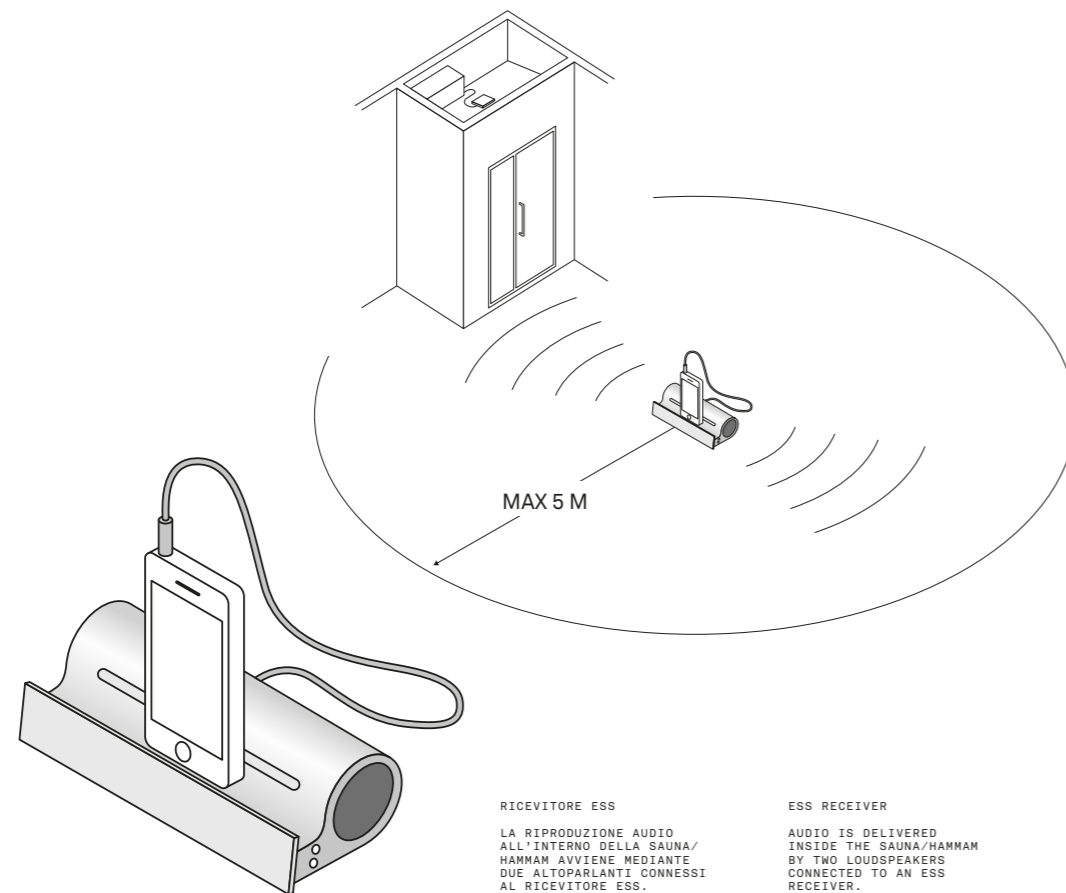

RICEVITORE ESS

LA RIPRODUZIONE AUDIO ALL'INTERNO DELLA SAUNA/HAMMAM AVVIENE MEDIANTE DUE ALTOPARLANTI CONNESSI AL RICEVITORE ESS.

ESS RECEIVER

AUDIO IS DELIVERED INSIDE THE SAUNA/HAMMAM BY TWO LOUSPEAKERS CONNECTED TO AN ESS RECEIVER.

# ECC

EFFEGIBI COMFORT CONTROL

Sistema che consente di gestire a distanza il bagno turco o la sauna, scaricando l'apposita App Effegibi Experience sul proprio Tablet o Smartphone. È possibile personalizzare la propria esperienza comodamente da altri ambienti della casa ed eseguire funzioni quali impostazione dell'ora di accensione, della temperatura e selezione della luce preferita.

Inoltre la copertura Wi-Fi nell'ambiente in cui sono inseriti il bagno turco o la sauna, permette una programmazione remota da qualsiasi luogo (ufficio-auto ecc.). Infine l'App Effegibi Experience permette di avere informazioni utili sull'utilizzo del prodotto: da come utilizzarli al meglio a quali sono i suoi benefici fino alla storia di questo rito antico.

This system can control remotely the sauna or the Turkish bath. To enable it, just download the app Effegibi Experience to your Tablet or Smartphone. This makes it possible to personalise your own experience conveniently from other places in your home and pre-set such functions as switch-on time, temperature and your preferred light selection.

What's more, the Wi-Fi cover in the sauna or hammam area enables you to program it remotely from almost any other location, such as your office or car.

Last but not least, the Effegibi Experience app provides you with useful information about the product, such as how to get the best out of your sauna or your hammam and its health benefits, as well as historical notes on this centuries-old tradition.

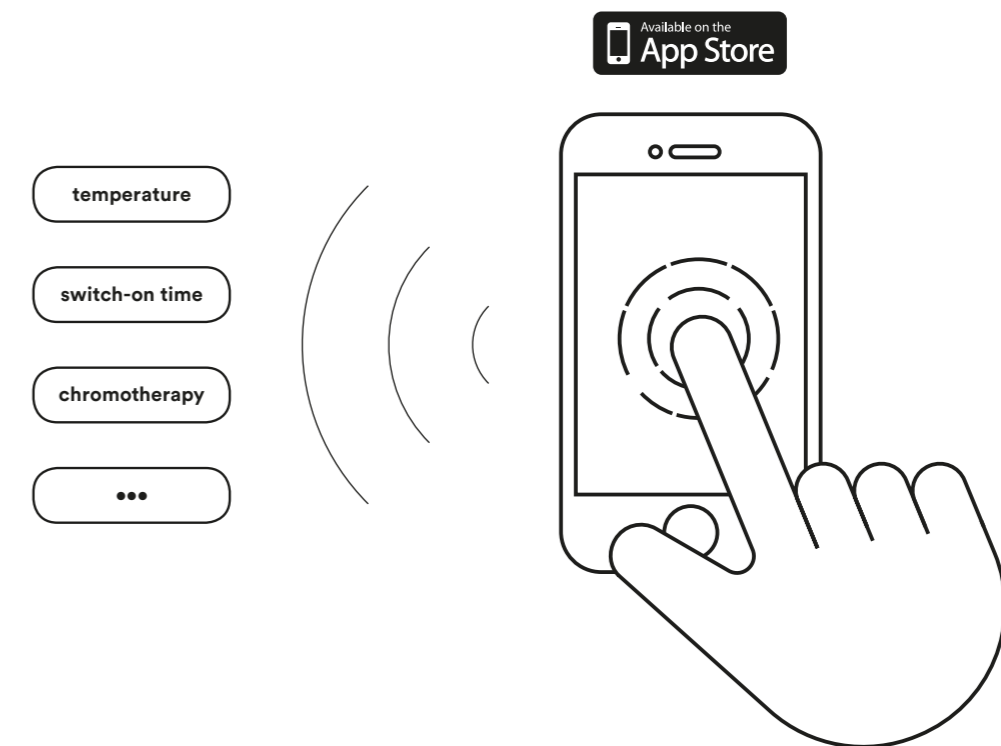



ESS  
Effegibi Sound System

# Doors and glass panels

PORTE E VETRATE

Le speciali porte Effegibi per hammam sono progettate per ottenere una tenuta perfetta alla fuoriuscita del vapore, garantendo il giusto ricircolo d'aria.

L'acciaio inox, l'alluminio e il vetro temperato di 8 mm di spessore rendono ogni modello molto durevole e facilmente abbinabile allo stile di ogni arredamento.

Grazie alle porte Effegibi, anche la semplice doccia di casa può essere trasformata in un perfetto bagno turco.

The special doors created by Effegibi for Hammams are designed to ensure a perfect seal against the escape of steam thus ensuring proper air circulation. Stainless steel and 8mm-thick toughened glass make each model tough and long-lasting and easily adaptable to any furnishing style.

Effegibi's special doors also enable any ordinary home shower to be transformed into the perfect Turkish bath.

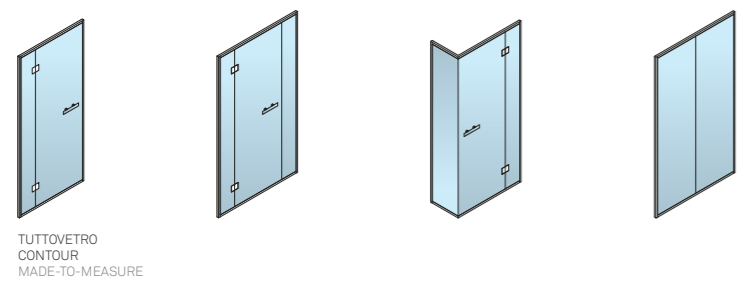
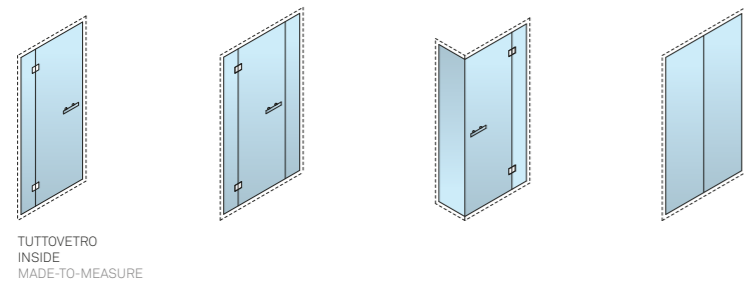
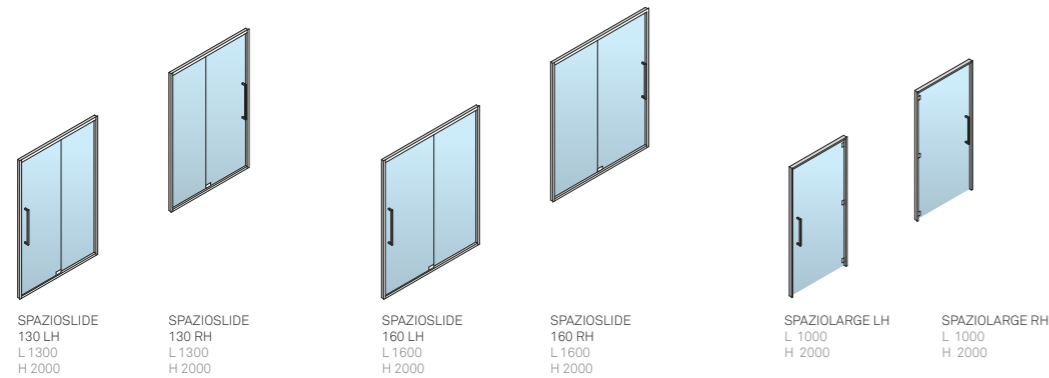

# Spazioslide



SPAZIOSLIDE 180

## CARATTERISTICHE

- **Apertura scorrevole**
- **Disponibile in versione destra o sinistra**
- **Installata su contro telaio**
- **Profili in acciaio**

## FEATURES

- **Sliding version**
- **Right or left-opening options**
- **Fitted to the counterframe**
- **Steel edges**

# Spaziofilo



SPAZIOFILO 180

## CARATTERISTICHE

- **Porta con apertura classica**
- **A filo pavimento**
- **Installata su contro telaio**
- **Profili in acciaio**

## FEATURES

- **Classic pull-open door**
- **Flush with the flooring**
- **Fitted to the counterframe**
- **Steel edges**

# Spazio

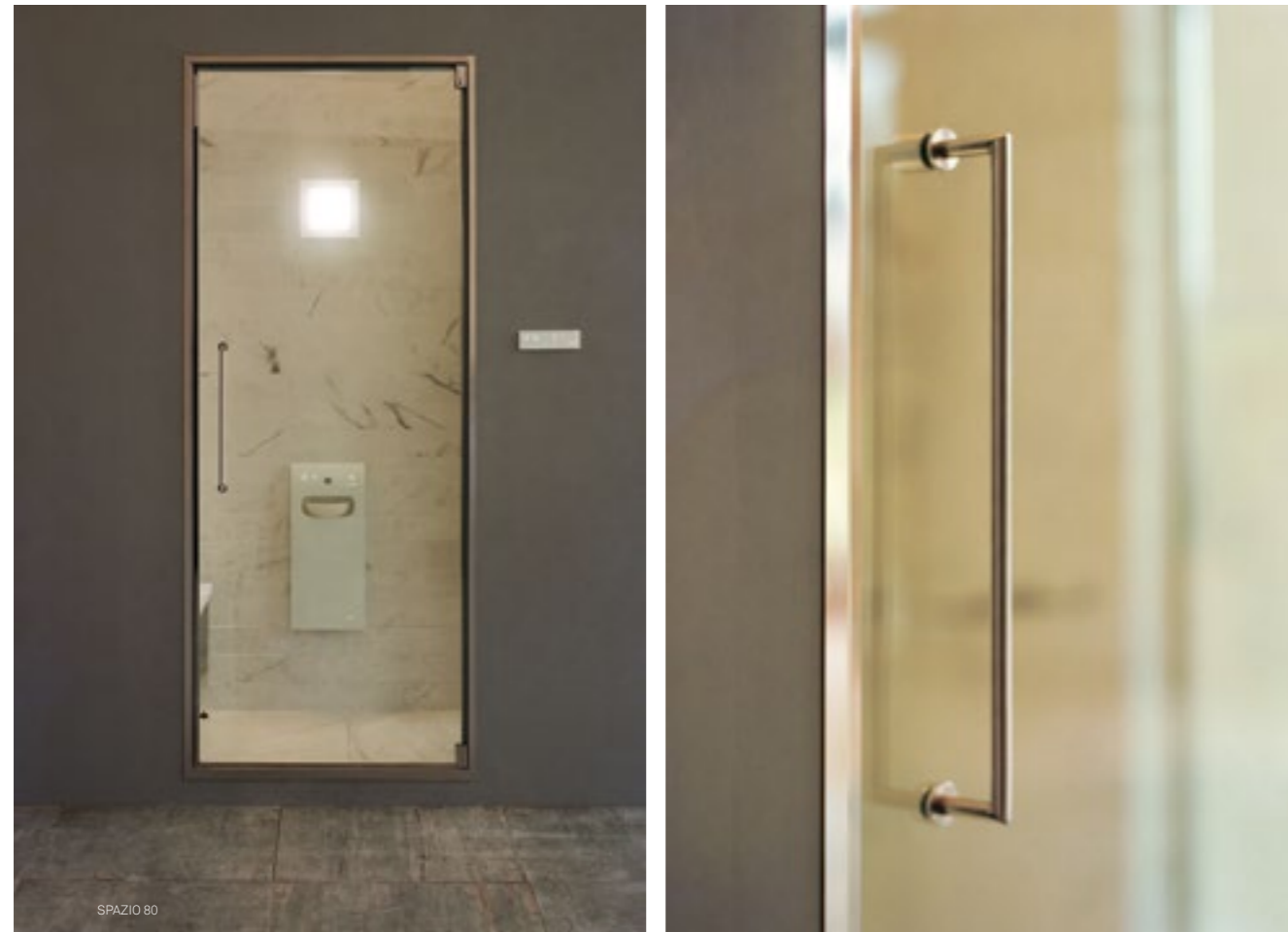

SPAZIO 80

CARATTERISTICHE

- **Reversibile**
- **Installata su controtelaio**
- **Profili in acciaio**

FEATURES

- **Reversibile**
- **Fitted to the counterframe**
- **Steel edges**

# Tuttovetro

Contour

Inside



CARATTERISTICHE

- **Porta con apertura classica**
- **Realizzabile su misura, h max 250 cm**
- **Contour:**
- **installata su telaio esterno**
- **in alluminio.**
- **Inside:**
- **installata su controtelaio,**
- **a filo pavimento.**

FEATURES

- **Classic pull-open door**
- **Can be made to measure, max height 250cm**
- **Contour:**
- **fitted to the aluminum frame**
- **mounted externally to the brickwork.**
- **Inside:**
- **fitted to the aluminium frame**
- **concealed in the brickwork**
- **flush with the flooring.**



# Smart



SMART 65

## CARATTERISTICHE

- Porta con apertura classica
- Colorazione: bianco o alluminio
- Realizzabile su misura
- Profili in alluminio

## FEATURES

- Classic pull-open door
- Colours: white or aluminium
- Can be made to measure
- Aluminium edges

# Smart Angolo



## CARATTERISTICHE

- Porta con apertura classica
- Colorazione: bianco o alluminio
- Realizzabile su misura
- Profili in alluminio

## FEATURES

- Classic pull-open door
- Colours: white or aluminium
- Can be made to measure
- Aluminium edges





TOPKAPI BENCH  
MODELS: 75 - 115



LOGICA BENCH



MINI SEAT AND MINI SPRING  
MODEL: COLOURED RESIN AMBER



MINI SEAT  
MODEL: COLOURED RESIN AMBER



MINI SPRING  
MODEL: CRISTALPLANT WHITE



MINI SPRING  
MODEL: TECK



LINEA ALU BENCH  
MODEL: CORNER - TECK



LINEA ALU BENCH  
MODEL: 3 MODULE - CRISTALPLANT WHITE

Mini  
Spring



Linea Alu  
Bench



# Other accessories

ARREDI E ACCESSORI

Effegibi ha studiato complementi d'arredo come poltrone, lettini, tavoli e chaise longue, che si abbinano a saune e hammam per completare con stile la vostra area benessere.

Effegibi has designed a complete range of fittings for saunas and Hammams with armchairs, loungers, tables and chaise longues to complete your spa area in style.





**Kneipp**  
Shower Hose



**Bodylove**  
Relax lounger



HAMMAM & SAUNA  
ESSENCES

# Aromateraphy

AROMATERAPIA

**I prodotti Effegibi sono predisposti per la diffusione di essenze profumate che completano l'atmosfera magica di sauna e hammam.**

**Effegibi products are set up for using aromatic oils to complete the magical atmosphere of the sauna and hammam.**

# BodyLove

**DIMENSIONI**

SAUNA+HAMMAM:  
CM 393 X 176 X 220 H  
SAUNA:  
CM 200 X 176 X 220 H  
HAMMAM:  
CM 200 X 176 X 220 H

**TAILOR MADE**

REALIZZABILE SU MISURA  
PIASTRELLABILE INTERNAMENTE  
ANCHE CON ALTRI RIVESTIMENTI.

**FINITURE PER SAUNA:**

HEMLOCK CANADESE;  
LEGNO MASSICCIO TERMOTRATTATO.

**FINITURE PER HAMMAM:**

GRES PORCELLANATO CHAMPAGNE;  
GRES PORCELLANATO AUVERGNE;  
VETRO A CANNE (FLUTES).

**COMPONENTI HAMMAM:**

GENERATORE NUVOLA SMART POWER  
ISPEZIONABILE DALL'ESTERNO;  
PANNELLO DI COMANDI TOUCH;  
VETRI EXTRACHIARI 10 MM;  
TETTO IN GRES PORCELLANATO;  
HAMMAM PANCHE IN CORIAN (BIANCO);  
CROMOTERAPIA A LED RGB;  
SOFFIONE DOCCIA ROTONDO;  
BASE FONTE IN MARMO BOTTICINO;  
CIOTOLA FONTE IN ACCIAIO COTTO,  
COLOR RAME.

**COMPONENTI SAUNA:**

VETRI EXTRACHIARI 10 MM;  
PANCHE IN LEGNO;  
STUFA CON PIETRE;  
COPRISTUFA IN CERAMICA SMALTATA;  
PANNELLO DI CONTROLLO FINITURA  
ACCIAIO SPAZZOLATO;  
MASTELLINO E MESTOLO IN LEGNO;  
CLESSIDRA.  
IMPIANTO ELETTRICO CANALIZZATO;  
ILLUMINAZIONE CON CROMOTERAPIA  
A LED RGB, 5 COLORI FISSI, 4 CICLI  
DINAMICI E LUCE BIANCA.

**DIMENSIONS**

SAUNA+HAMMAM:  
CM 393 X 176 X 220 H  
SAUNA:  
CM 200 X 176 X 220 H  
HAMMAM:  
CM 200 X 176 X 220 H

**TAILOR MADE**

IT IS FEASIBLE CUSTOM-MADE  
IT IS POSSIBLE TO APPLY DIFFERENT  
CLADDINGS INTERNALLY.

**SAUNA MATERIALS:**

CANADIAN HEMLOCK;  
SOLID WOOD HEAT TREATED.

**HAMMAM MATERIALS:**

GRES PORCELAIN CHAMPAGNE;  
GRES PORCELAIN AUVERGNE;  
FLUTED GLASS.

**HAMMAM INCLUDES:**

BUILT IN STEAM GENERATOR NUVOLA  
SMART POWER;  
TOUCH-SCREEN CONTROL PANEL;  
CLEAR TEMPERED GLASS 10 MM;  
GRES PORCELAIN WHITE TOP;  
WHITE CORIAN BENCHES;  
LIGHTING SYSTEM WITH LED RGB  
COLOUR THERAPY;  
CEILING MOUNTED SHOWER HEAD;  
SPRING WHITH BOTTICINO MARBLE  
AND COPPER-FINISH STEEL BOWL.

**SAUNA INCLUDES:**

CLEAR TEMPERED GLASS 10 MM  
WOODEN BENCHES;  
HEATER WITH STONES;  
CERAMIC TILES COVER HEATER;  
CONTROL PANEL WITH BRUSHED  
STEEL FINISH;  
WOODEN BUCKET AND LADLE;  
HOURGLASS.  
ELECTRICAL SYSTEM WITH  
PROTECTED CABLE DUCTS;  
LED RGB LIGHTING SYSTEM,  
5 FIXED COLOURS, 4 DYNAMIC  
CYCLES AND WHITE LIGHT.

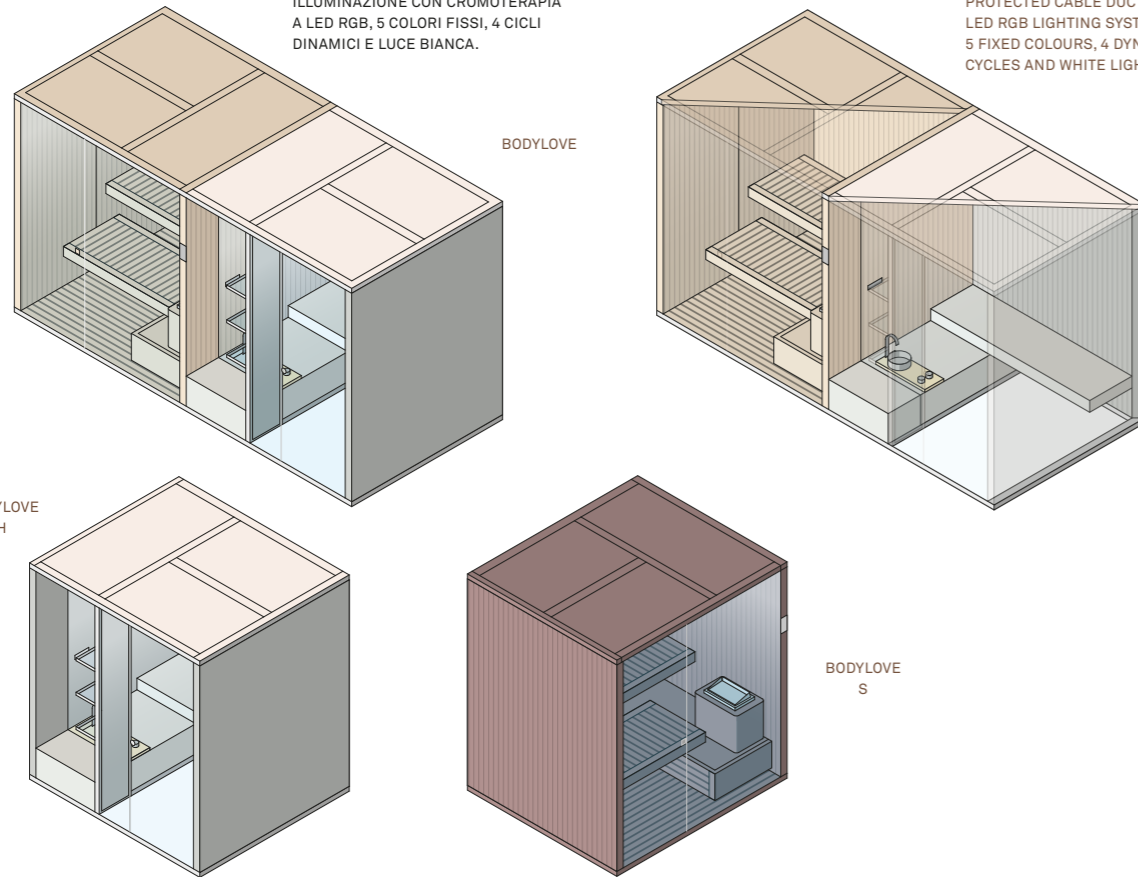

**CONFIGURATIONS,  
EXAMPLES(\*):**

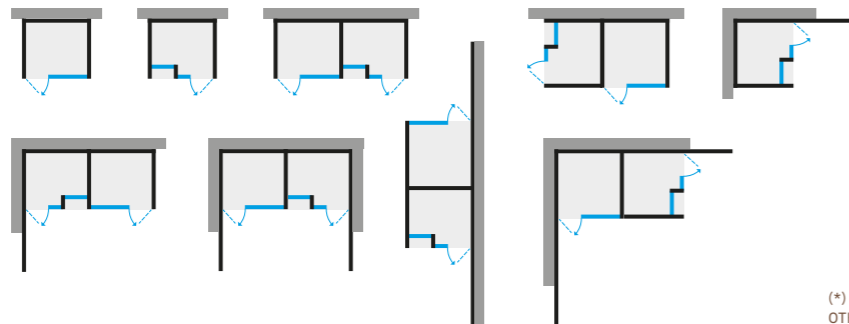

(\*)  
OTHER LAYOUTS CAN BE SEEN  
ON THE EFFEGIBI WEBSITE: WWW.EFFEGIBI.IT

# Finishes Finiture

## SAUNA



HEAT-TREATED  
SOLID WOOD



CANADIAN  
HEMLOCK

Rivestimento interno,  
boiserie (opt.)  
Inside walls,  
boiserie (opt.)

## HAMMAM



GRES PORCELAIN  
AUVERGNE

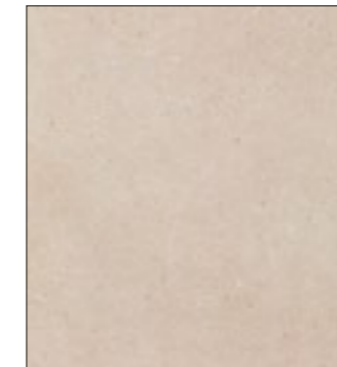

GRES PORCELAIN  
CHAMPAGNE



FLUTED GLASS

Rivestimento  
interno,  
boiserie (opt.)  
Inside walls,  
boiserie (opt.)



# Logica

## DIMENSIONI

CM 373 X 250 X 226 H

## POTENZA ASSORBITA

10,5 KW MAX  
230 VAC 1N 50-60 HZ  
400 VAC 3N 50-60 HZ

## FINITURE

ALLUMINIO VERNICIATO;  
PARETI ESTERNE A VISTA GRES  
LAMINATO 3,5 MM.

## MATERIALI SAUNA

INTERNO ED ARREDI:  
HEMLOCK CANADESE;  
PORTE IN VETRO TEMPERATO 8 MM.  
PEDANA: GRES LAMINATO 3,5 MM;  
ACCOPPIATO SU VETRO TEMPERATO  
15 MM.

## MATERIALI HAMMAM

INTERNO ED ARREDI:  
GRES LAMINATO 3,5 MM;  
PORTE IN VETRO TEMPERATO 8 MM.  
PEDANA: GRES LAMINATO 3,5 MM  
ACCOPPIATO SU VETRO TEMPERATO  
15 MM.

## MATERIALI DOCCIA

PEDANA: GRES LAMINATO 3,5 MM  
ACCOPPIATO SU VETRO TEMPERATO  
15 MM.

## SAUNA COMPLETA DI:

PANCHE IN LEGNO;  
STUFA CON PIETRE;  
PANNELLO DI CONTROLLO TOUCH;  
FUNZIONE ENERGY SAVER AUTOMATICA;  
MASTELLINO INTEGRATO NELLA PANCA  
INFERIORE;  
MESTOLO IN LEGNO;  
CLESSIDRA.  
IMPIANTO ELETTRICO CANALIZZATO;  
ILLUMINAZIONE CON CROMOTERAPIA  
A LED RGB, 5 COLORI FISSI,  
4 CICLI DINAMICI E LUCE BIANCA.

## HAMMAM COMPLETO DI:

AQUASTEAM 45;  
PANCHE IN GRES LAMINATO;  
ILLUMINAZIONE CON CROMOTERAPIA  
A LED RGB, 5 COLORI FISSI,  
4 CICLI DINAMICI E LUCE BIANCA.

## DOCCIA COMPLETA DI:

MISCELATORE CON CARTUCCIA  
PROGRESSIVA E DEVIATORE;  
SOFFIONE DOCCIA A SOFFITTO CON  
ANTICALCARE;  
DOCCIA A MANO.

## ECC - EFFEGIBI COMFORT CONTROL

IL SISTEMA INTEGRATO CHE  
CONSENTE DI GESTIRE A DISTANZA  
SAUNA E BAGNO TURCO, SCARICANDO  
L'APPOSITA APP EFFEGIBI EXPERIENCE  
SUL PROPRIO TABLET O SMARTPHONE.

## DIMENSIONS

CM 373 X 250 X 226 H

## ABSORBED POWER

10.5 KW MAX  
230 VAC 1N 50-60 HZ  
400 VAC 3N 50-60 HZ

## OUTSIDE WALL FINISH

PAINTED ALUMINIUM;  
OUTSIDE WALL FINISH LAMINATED  
GRÈS PORCELAIN 3.5 MM.

## SAUNA MATERIALS

INSIDE AND FITTINGS:  
CANADIAN HEMLOCK;  
DOORS IN 8 MM TEMPERED GLASS.  
PLATFORM: 3.5 MM LAMINATED  
GRES PORCELAIN FITTED TO 15 MM  
TOUGHENED GLASS.

## HAMMAM MATERIALS

INSIDE AND FITTINGS:  
3.5 MM LAMINATED GRES PORCELAIN;  
DOORS IN 8 MM TEMPERED GLASS.  
PLATFORM: 3.5 MM LAMINATED  
GRES PORCELAIN FITTED TO 15 MM  
TOUGHENED GLASS.

## SHOWER MATERIALS

PLATFORM: 3.5 MM LAMINATED  
GRES PORCELAIN FITTED TO 15 MM  
TOUGHENED GLASS.

## SAUNA INCLUDES:

WOODEN BENCHES;  
HEATER WITH STONES;  
TOUCH CONTROL PANEL;  
AUTOMATIC ENERGY SAVING FUNCTION;  
BUCKET BUILT INTO THE LOWER BENCH;  
WOODEN LADLE;  
HOURGLASS.  
ELECTRICAL SYSTEM WITH PROTECTED  
CABLE DUCTS;  
LIGHTING SYSTEM WITH LED RGB  
COLOUR THERAPY, 5 FIXED COLOURS,  
4 DYNAMIC CYCLES AND WHITE LIGHT.

## HAMMAM INCLUDES:

AQUASTEAM 45;  
UNGLAZED PORCELAIN TILE BENCHES;  
LIGHTING SYSTEM WITH LED RGB  
COLOUR THERAPY, 5 FIXED COLOURS,  
4 DYNAMIC CYCLES AND WHITE LIGHT.

## SHOWER INCLUDES:

MIXER TAP WITH FLOW REGULATOR  
AND DIVERTER;  
CEILING MOUNTED ANTI-SCALE  
SHOWER HEAD;  
HAND-HELD SHOWER HEAD.

## ECC - EFFEGIBI COMFORT CONTROL

THIS SYSTEM IS INCORPORATED  
SO THAT THE SAUNA AND THE TURKISH  
BATH CAN BE REMOTELY CONTROLLED,  
JUST DOWNLOAD THE APP EFFEGIBI  
EXPERIENCE TO YOUR TABLET OR  
SMARTPHONE.

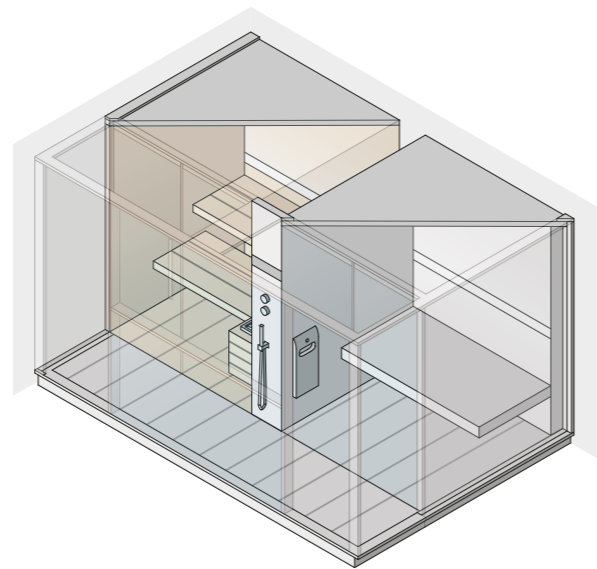
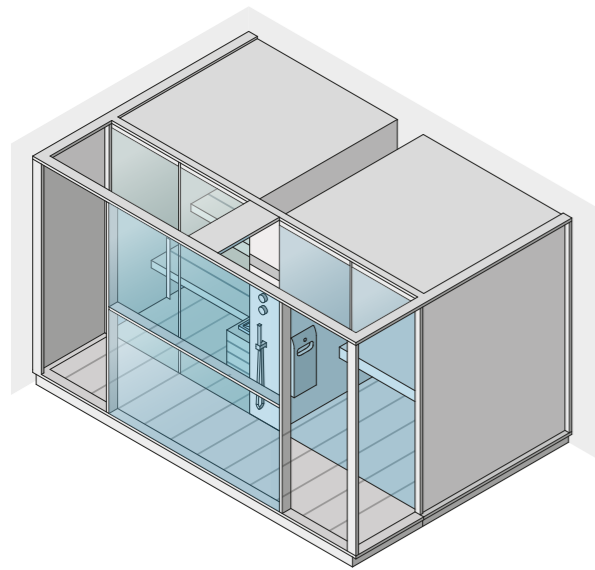

CONFIGURATIONS,  
EXAMPLES(\*):

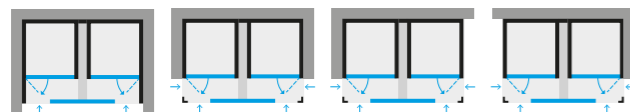
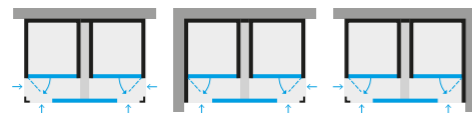

(\*) OTHER LAYOUTS CAN BE SEEN  
ON THE EFFEGIBI WEBSITE: WWW.EFFEGIBI.IT

# Finishes Finiture

## SAND

### SOFT SAND

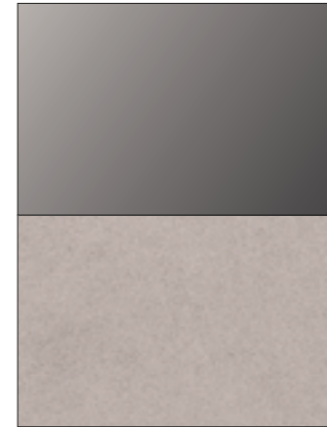

PAINTED ALUMINIUM  
(GRAY) RAL 7030 + SLIMTECH  
SOFT SAND

### SAND C030

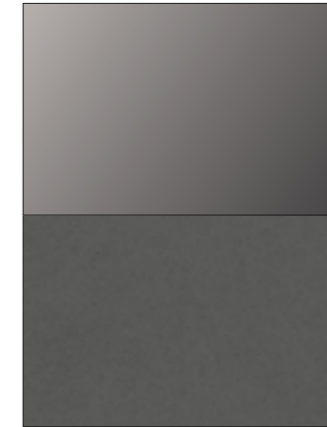

PAINTED ALUMINIUM  
(GRAY) RAL 7030 + SLIMTECH  
RE-EVOLUTION  
C030

### SAND W030

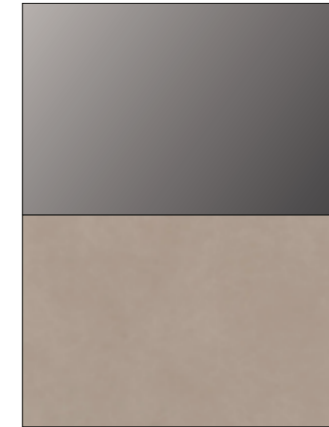

PAINTED ALUMINIUM  
(GRAY) RAL 7030 + SLIMTECH  
RE-EVOLUTION  
W030

Struttura  
esterna  
Outside  
structure

Pareti esterne  
e interne  
Outside and inside  
walls

## CLOUD

### WHITE CLOUD

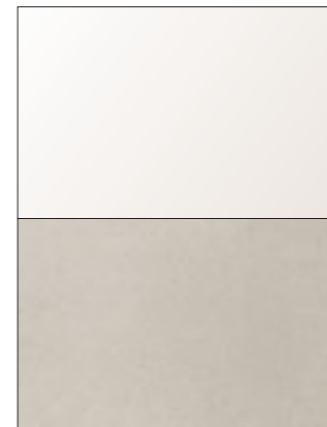

PAINTED ALUMINIUM  
(WHITE) RAL 9010 SA810G + SLIMTECH  
WHITE CLOUD

### CLOUD C020

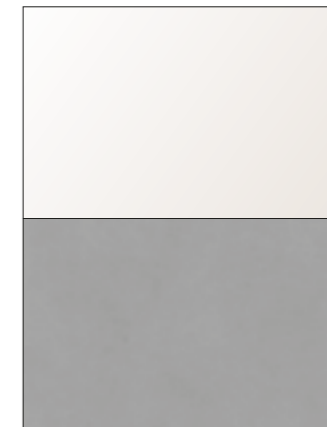

PAINTED ALUMINIUM  
(WHITE) RAL 9010 SA810G + SLIMTECH  
RE-EVOLUTION  
C020

### CLOUD W030



PAINTED ALUMINIUM  
(WHITE) RAL 9010 SA810G + SLIMTECH  
RE-EVOLUTION  
W030

Struttura  
esterna  
Outside  
structure

Pareti esterne  
e interne  
Outside and inside  
walls

## STONE



PAINTED ALUMINIUM (BROWN)  
YX355F MARS 2525 SABLÉ + SLIMTECH  
BLACK STONE

Struttura  
esterna  
Outside  
structure

Pareti esterne  
e interne  
Outside and inside  
walls

# Logica SH

## DIMENSIONI

CM 373 X 171 X 226 H

## POTENZA ASSORBITA

10,5 KW MAX  
230 VAC 1N 50-60 HZ  
400 VAC 3N 50-60 HZ

## FINITURE

ALLUMINIO VERNICIATO;  
PARETI ESTERNE A VISTA GRES  
LAMINATO 3,5 MM.

## MATERIALI SAUNA

INTERNO ED ARREDI:  
HEMLOCK CANADESE;  
PORTE IN VETRO TEMPERATO 8 MM.  
PEDANA: GRES LAMINATO 3,5 MM  
ACCOPPIATO SU VETRO TEMPERATO  
15 MM.

## MATERIALI HAMMAM

INTERNO ED ARREDI:  
GRES LAMINATO 3,5 MM;  
PORTE IN VETRO TEMPERATO 8 MM.  
PEDANA: GRES LAMINATO 3,5 MM  
ACCOPPIATO SU VETRO TEMPERATO  
15 MM.

## SAUNA COMPLETA DI:

PANCHE IN LEGNO;  
STUFA CON PIETRE;  
PANNELLO DI CONTROLLO TOUCH;  
FUNZIONE ENERGY SAVER AUTOMATICA;  
MASTELLINO INTEGRATO NELLA PANCA  
INFERIORE;  
MESTOLO IN LEGNO;  
CLESSIDRA.  
IMPIANTO ELETTRICO CANALIZZATO;  
ILLUMINAZIONE CON CROMOTERAPIA  
A LED RGB, 5 COLORI FISSI, 4 CICLI  
DINAMICI E LUCE BIANCA.

## HAMMAM COMPLETO DI:

AQUASTEAM 45;  
PANCHE IN GRES LAMINATO;  
ILLUMINAZIONE CON CROMOTERAPIA  
A LED RGB, 5 COLORI FISSI, 4 CICLI  
DINAMICI E LUCE BIANCA.

## ECC - EFFEGIBI COMFORT CONTROL

IL SISTEMA INTEGRATO CHE  
CONSENTE DI GESTIRE A DISTANZA  
SAUNA E BAGNO TURCO, SCARICANDO  
L'APPOSITA APP EFFEGIBI EXPERIENCE  
SUL PROPRIO TABLET O SMARTPHONE.

## DIMENSIONS

CM 373 X 171 X 226 H

## ABSORBED POWER

10.5 KW MAX  
230 VAC 1N 50-60 HZ  
400 VAC 3N 50-60 HZ

## OUTSIDE WALL FINISH

PAINTED ALUMINIUM;  
OUTSIDE WALL FINISH LAMINATED  
GRÈS PORCELAIN 3.5 MM.

## SAUNA MATERIALS

INSIDE AND FITTINGS:  
CANADIAN HEMLOCK;  
DOORS IN 8 MM TEMPERED GLASS.  
PLATFORM: 3.5 MM LAMINATED  
GRES PORCELAIN FITTED TO 15 MM  
TOUGHENED GLASS.

## HAMMAM MATERIALS

INSIDE AND FITTINGS:  
3.5 MM LAMINATED GRES PORCELAIN;  
DOORS IN 8 MM TEMPERED GLASS  
PLATFORM: 3.5 MM LAMINATED  
GRES PORCELAIN FITTED TO 15 MM  
TOUGHENED GLASS.

## SAUNA INCLUDES:

WOODEN BENCHES;  
HEATER WITH STONES;  
TOUCH CONTROL PANEL;  
AUTOMATIC ENERGY SAVING FUNCTION;  
BUCKET BUILT INTO THE LOWER BENCH;  
WOODEN LADLE;  
HOURGLASS.  
ELECTRICAL SYSTEM WITH PROTECTED  
CABLE DUCTS;  
LIGHTING SYSTEM WITH LED RGB  
COLOUR THERAPY, 5 FIXED COLOURS,  
4 DYNAMIC CYCLES AND WHITE LIGHT.

## HAMMAM INCLUDES:

AQUASTEAM 45;  
UNGLAZED PORCELAIN TILE BENCHES;  
LIGHTING SYSTEM WITH LED RGB  
COLOUR THERAPY, 5 FIXED COLOURS,  
4 DYNAMIC CYCLES AND WHITE LIGHT.

## ECC - EFFEGIBI COMFORT CONTROL

THIS SYSTEM IS INCORPORATED  
SO THAT THE SAUNA AND THE TURKISH  
BATH CAN BE REMOTELY CONTROLLED,  
JUST DOWNLOAD THE APP EFFEGIBI  
EXPERIENCE TO YOUR TABLET OR  
SMARTPHONE.

# Logica S

## DIMENSIONI

CM 214 X 250 X 226 H

## POTENZA ASSORBITA

6,0 KW MAX  
230 VAC 1N 50-60 HZ  
400 VAC 3N 50-60 HZ

## FINITURE

ALLUMINIO VERNICIATO;  
PARETI ESTERNE A VISTA GRES  
LAMINATO 3,5 MM.

## MATERIALI SAUNA

INTERNO ED ARREDI:  
HEMLOCK CANADESE;  
PORTE IN VETRO TEMPERATO 8 MM.  
PEDANA: GRES LAMINATO 3,5 MM  
ACCOPPIATO SU VETRO TEMPERATO  
15 MM.

## MATERIALI DOCCIA

PEDANA: GRES LAMINATO 3,5 MM  
ACCOPPIATO SU VETRO TEMPERATO  
15 MM.

## SAUNA COMPLETA DI:

PANCHE IN LEGNO;  
STUFA CON PIETRE;  
PANNELLO DI CONTROLLO TOUCH;  
FUNZIONE ENERGY SAVER AUTOMATICA;  
MASTELLINO INTEGRATO NELLA PANCA  
INFERIORE;  
MESTOLO IN LEGNO;  
CLESSIDRA.  
IMPIANTO ELETTRICO CANALIZZATO;  
ILLUMINAZIONE CON CROMOTERAPIA  
A LED RGB, 5 COLORI FISSI, 4 CICLI  
DINAMICI E LUCE BIANCA.

## DOCCIA COMPLETA DI:

MISCELATORE CON CARTUCCIA  
PROGRESSIVA E DEVIATORE;  
SOFFIONE DOCCIA A SOFFITTO  
CON ANTICALCARE;  
DOCCIA A MANO.

## ECC - EFFEGIBI COMFORT CONTROL

IL SISTEMA INTEGRATO CHE  
CONSENTE DI GESTIRE A DISTANZA LA  
SAUNA, SCARICANDO L'APPOSITA APP  
EFFEGIBI EXPERIENCE SUL PROPRIO  
TABLET O SMARTPHONE.

## DIMENSIONS

CM 214 X 250 X 226 H

## ABSORBED POWER

6.0 KW MAX  
230 VAC 1N 50-60 HZ  
400 VAC 3N 50-60 HZ

## OUTSIDE WALL FINISH

PAINTED ALUMINIUM;  
OUTSIDE WALL FINISH LAMINATED  
GRÈS PORCELAIN 3.5 MM.

## SAUNA MATERIALS

INSIDE AND FITTINGS:  
CANADIAN HEMLOCK;  
DOORS IN 8 MM TEMPERED GLASS.  
PLATFORM: 3.5 MM LAMINATED  
GRES PORCELAIN FITTED TO 15 MM  
TOUGHENED GLASS.

## SHOWER MATERIALS

PLATFORM: 3.5 MM LAMINATED  
GRES PORCELAIN FITTED TO 15 MM  
TOUGHENED GLASS.

## SAUNA INCLUDES:

WOODEN BENCHES;  
HEATER WITH STONES;  
TOUCH CONTROL PANEL;  
AUTOMATIC ENERGY SAVING FUNCTION;  
BUCKET BUILT INTO THE LOWER BENCH;  
WOODEN LADLE;  
HOURGLASS.  
ELECTRICAL SYSTEM WITH PROTECTED  
CABLE DUCTS;  
LIGHTING SYSTEM WITH LED RGB  
COLOUR THERAPY, 5 FIXED COLOURS 4  
DYNAMIC CYCLES AND WHITE LIGHT.  
AUDIO SET-UP WITH BUILT-IN SPEAKERS  
AND ESS-EFFEGIBI SOUND SYSTEM.

## SHOWER INCLUDES:

MIXER TAP WITH FLOW REGULATOR  
AND DIVERTER;  
CEILING MOUNTED ANTI-SCALE  
SHOWER HEAD;  
HAND-HELD SHOWER HEAD.

## ECC - EFFEGIBI COMFORT CONTROL

THIS SYSTEM IS INCORPORATED SO  
THAT THE SAUNA CAN BE REMOTELY  
CONTROLLED, JUST DOWNLOAD THE APP  
EFFEGIBI EXPERIENCE TO YOUR TABLET  
OR SMARTPHONE.

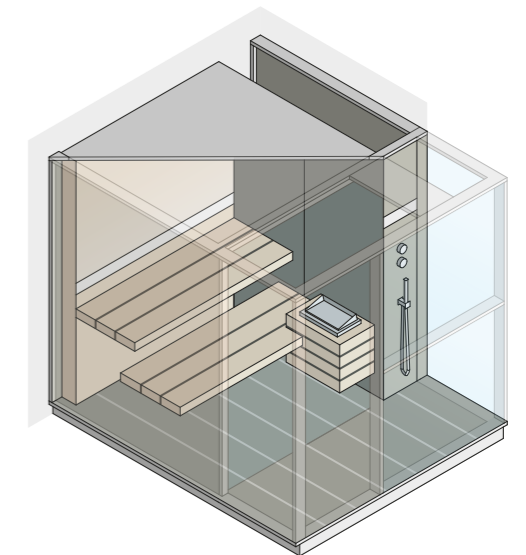
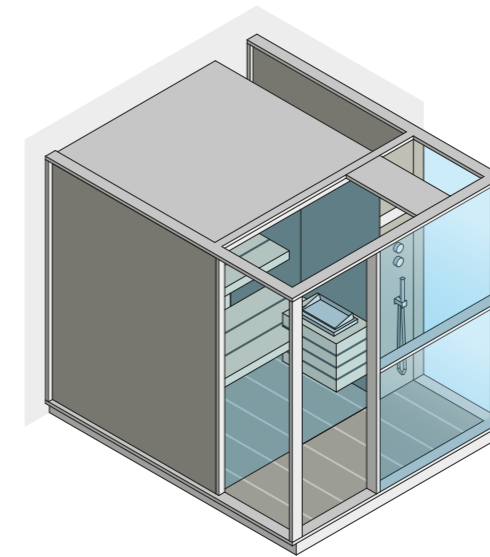
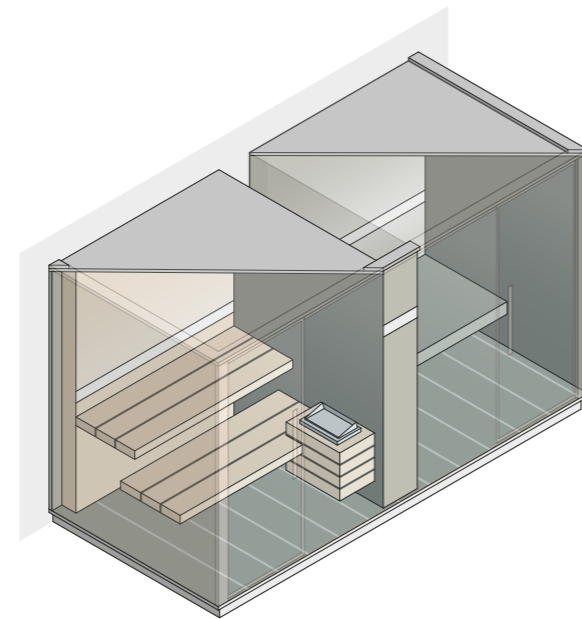
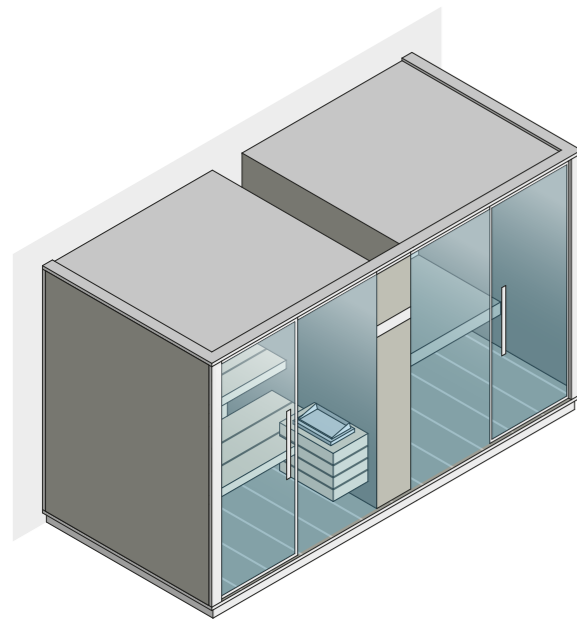

CONFIGURATIONS,  
EXAMPLES(\*):

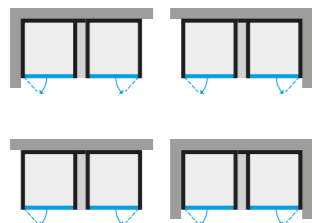

CONFIGURATIONS,  
EXAMPLES(\*):

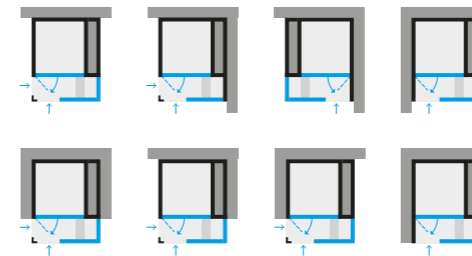

(\*)  
OTHER LAYOUTS CAN BE SEEN  
ON THE EFFEGIBI WEBSITE: WWW.EFFEGIBI.IT

# Logica H

**DIMENSIONI**  
CM 214 X 250 X 226 H

**POTENZA ASSORBITA**  
4,5 KW MAX  
230 VAC 1N 50-60 HZ  
400 VAC 3N 50-60 HZ

**FINITURE**  
ALLUMINIO VERNICIATO;  
PARETI ESTERNE A VISTA GRES  
LAMINATO 3,5 MM.

**MATERIALI HAMMAM**  
INTERNO ED ARREDI:  
GRES LAMINATO 3,5 MM;  
PORTE IN VETRO TEMPERATO 8 MM.  
PEDANA: GRES LAMINATO 3,5 MM  
ACCOPPIATO SU VETRO TEMPERATO 15 MM.

**MATERIALI DOCCIA**  
PEDANA: GRES LAMINATO 3,5 MM  
ACCOPPIATO SU VETRO TEMPERATO  
15 MM.

**HAMMAM COMPLETO DI:**  
AQUASTEAM 45;  
PANCHE IN GRES LAMINATO;  
ILLUMINAZIONE CON CROMOTERAPIA  
A LED RGB, 5 COLORI FISSI, 4 CICLI  
DINAMICI E LUCE BIANCA;

**DOCCIA COMPLETA DI:**  
MISCELATORE CON CARTUCCIA  
PROGRESSIVA E DEVIATORE;  
SOFFIONE DOCCIA A SOFFITTO CON  
ANTICALCARE;  
DOCCIA A MANO.

**ECC - EFFEGIBI COMFORT CONTROL**  
IL SISTEMA È INTEGRATO IN OGNI  
GENERATORE DI VAPORE EFFEGIBI E  
CONSENTE DI GESTIRE A DISTANZA IL  
BAGNO TURCO, SCARICANDO L'APPOSITA  
APP EFFEGIBI EXPERIENCE SUL PROPRIO  
TABLET O SMARTPHONE.

**DIMENSIONS**  
CM 214 X 250 X 226 H

**ABSORBED POWER**  
4,5 KW MAX  
230 VAC 1N 50-60 HZ  
400 VAC 3N 50-60 HZ

**OUTSIDE WALL FINISH**  
PAINTED ALUMINIUM;  
OUTSIDE WALL FINISH LAMINATED  
GRÈS PORCELAIN 3.5 MM.

**HAMMAM MATERIALS**  
INSIDE AND FITTINGS: 3.5 MM  
LAMINATED GRES PORCELAIN;  
DOORS IN 8 MM TEMPERED GLASS.  
PLATFORM: 3.5 MM LAMINATED  
GRES PORCELAIN FITTED TO 15 MM  
TOUGHENED GLASS.

**SHOWER MATERIALS**  
PLATFORM: 3.5 MM LAMINATED  
GRES PORCELAIN FITTED TO 15 MM  
TOUGHENED GLASS.

**HAMMAM INCLUDES:**  
AQUASTEAM 45;  
UNGLAZED PORCELAIN TILE BENCHES;  
LIGHTING SYSTEM WITH LED RGB  
COLOUR THERAPY, 5 FIXED COLOURS ,  
4 DYNAMIC CYCLES AND WHITE LIGHT.

**SHOWER INCLUDES:**  
MIXER TAP WITH FLOW REGULATOR  
AND DIVERTER;  
CEILING MOUNTED ANTI-SCALE  
SHOWER HEAD;  
HAND-HELD SHOWER HEAD.

**ECC - EFFEGIBI COMFORT CONTROL**  
THIS SYSTEM IS INCORPORATED INTO  
EVERY EFFEGIBI STEAM GENERATOR  
SO THAT THE TURKISH BATH CAN BE  
REMOVEDLY CONTROLLED. TO ENABLE  
IT, JUST DOWNLOAD THE APP EFFEGIBI  
EXPERIENCE TO YOUR TABLET OR  
SMARTPHONE.

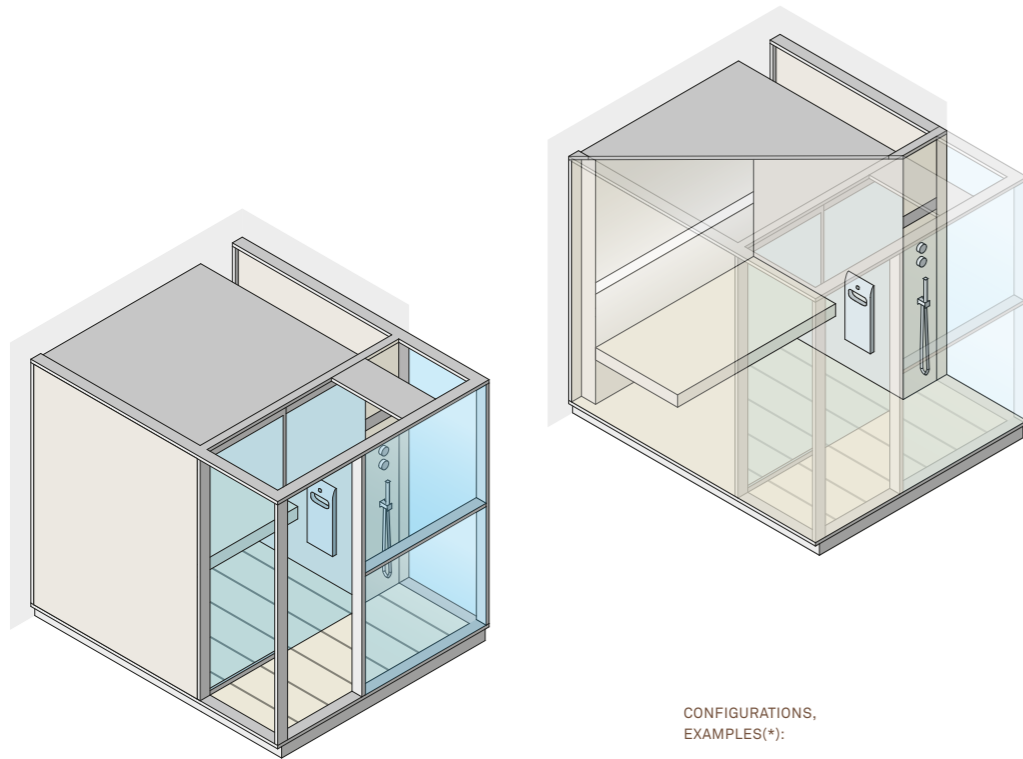

CONFIGURATIONS,  
EXAMPLES(\*):

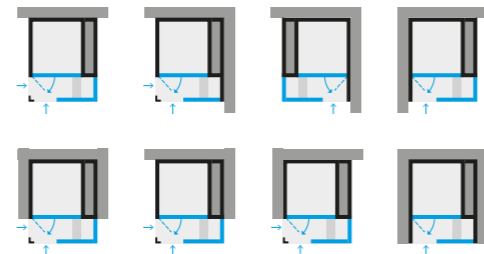

# Mid

**DIMENSIONI**  
CM 300 X 137 X 220 H

**POTENZA ASSORBITA**  
11,0 KW MAX  
230 VAC 1N 50-60 HZ  
400 VAC 3N 50-60 HZ

**FINITURE**  
ALLUMINIO VERNICIATO;  
PARETI ESTERNE A VISTA GRES  
LAMINATO 3,5 MM.

**MATERIALI SAUNA**  
INTERNO ED ARREDI:  
HEMLOCK CANADESE;  
PORTE IN VETRO TEMPERATO 8 MM.  
PEDANA: GRES LAMINATO 3,5 MM  
ACCOPPIATO SU VETRO TEMPERATO  
15 MM.

**MATERIALI HAMMAM - DOCCIA**  
INTERNO ED ARREDI:  
GRES LAMINATO 3,5 MM ACCOPPIATO SU  
VETRO TEMPERATO 15 MM;  
PORTE IN VETRO TEMPERATO 8 MM.  
PEDANA: GRES LAMINATO 3,5 MM  
ACCOPPIATO SU VETRO TEMPERATO  
15 MM.

**SAUNA COMPLETA DI:**  
PANCHE IN LEGNO;  
STUFA CON PIETRE;  
PANNELLO DI CONTROLLO TOUCH;  
FUNZIONE ENERGY SAVER AUTOMATICA;  
MASTELLINO E MESTOLO IN LEGNO;  
CLESSIDRA.  
IMPIANTO ELETTRICO CANALIZZATO;  
ILLUMINAZIONE CON CROMOTERAPIA  
A LED RGB, 5 COLORI FISSI, 4 CICLI  
DINAMICI E LUCE BIANCA.

**HAMMAM COMPLETO DI:**  
AQUASTEAM 30;  
PANCHE IN GRES LAMINATO;  
CANADIAN HEMLOCK  
DOORS IN 8 MM TEMPERED GLASS.  
PLATFORM: 3.5 MM LAMINATED  
GRES PORCELAIN FITTED TO 15 MM  
TOUGHENED GLASS.

**DOCCIA COMPLETA DI:**  
MISCELATORE TERMOSTATICO  
CON DEVIATORE A 3 VIE;  
DOCCIA A MANO;  
SOFFIONE DOCCIA A SOFFITTO  
42 X 42 CM, CON FUNZIONI PIOGGIA  
E NEBULIZZAZIONE.

**ECC - EFFEGIBI COMFORT CONTROL**  
IL SISTEMA È INTEGRATO CHE CONSENTE  
DI GESTIRE A DISTANZA LA SAUNA E IL  
BAGNO TURCO, SCARICANDO L'APPOSITA  
APP EFFEGIBI EXPERIENCE SUL PROPRIO  
TABLET O SMARTPHONE.

**DIMENSIONS**  
CM 300 X 137 X 220 H

**ABSORBED POWER**  
11.0 KW MAX  
230 VAC 1N 50-60 HZ  
400 VAC 3N 50-60 HZ

**OUTSIDE WALL FINISH**  
PAINTED ALUMINIUM;  
OUTSIDE WALL FINISH LAMINATED  
GRÈS PORCELAIN 3.5 MM.

**SAUNA MATERIALS**  
INSIDE AND FITTINGS:  
CANADIAN HEMLOCK  
DOORS IN 8 MM TEMPERED GLASS.  
PLATFORM: 3.5 MM LAMINATED  
GRES PORCELAIN FITTED TO 15 MM  
TOUGHENED GLASS.

**HAMMAM - SHOWER MATERIALS**  
INSIDE AND FITTINGS:  
3.5 MM LAMINATED GRES PORCELAIN  
FITTED TO 15 MM TOUGHENED GLASS;  
DOORS IN 8 MM TEMPERED GLASS.  
PLATFORM: 3.5 MM LAMINATED  
GRES PORCELAIN FITTED TO 15 MM  
TOUGHENED GLASS.

**SAUNA INCLUDES:**  
WOODEN BENCHES;  
HEATER WITH STONES;  
TOUCH CONTROL PANEL;  
AUTOMATIC ENERGY SAVING FUNCTION;  
BUCKET AND WOODEN LADLE;  
HOURLASS.  
ELECTRICAL SYSTEM WITH PROTECTED  
CABLE DUCTS;  
LIGHTING SYSTEM WITH LED RGB  
COLOUR THERAPY, 5 FIXED COLOURS,  
4 DYNAMIC CYCLES AND WHITE LIGHT.

**HAMMAM INCLUDES:**  
AQUASTEAM 45;  
UNGLAZED PORCELAIN TILE BENCHES;  
LIGHTING SYSTEM WITH LED RGB  
COLOUR THERAPY, 5 FIXED COLOURS  
4 DYNAMIC CYCLES AND WHITE LIGHT.

**SHOWER INCLUDES:**  
THERMOSTATIC MIXER WITH  
3-WAY DIVERTER;  
HAND-HELD SHOWER HEAD;  
42 X 42 CM CEILING-MOUNTED SHOWER  
HEAD WITH RAIN AND NEBULISER  
FUNCTIONS.

**ECC - EFFEGIBI COMFORT CONTROL**  
THIS SYSTEM IS INCORPORATED SO  
THAT THE SAUNA AND THE TURKISH  
BATH CAN BE REMOTELY CONTROLLED,  
JUST DOWNLOAD THE APP EFFEGIBI  
EXPERIENCE TO YOUR TABLET OR  
SMARTPHONE.

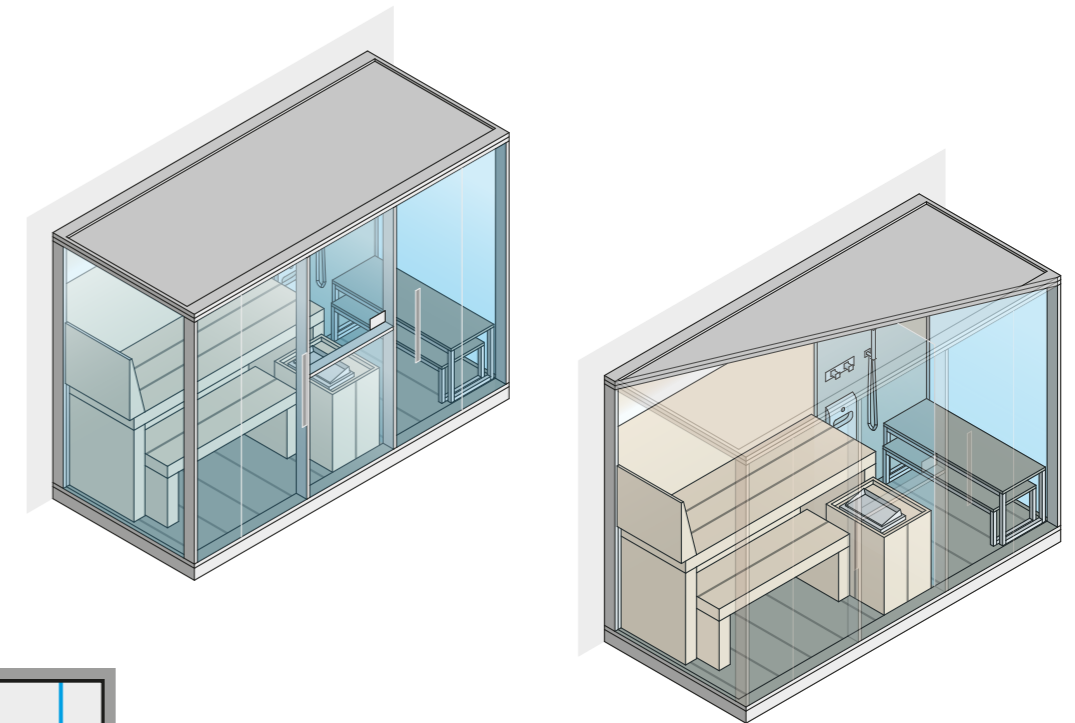

CONFIGURATIONS,  
EXAMPLES(\*):

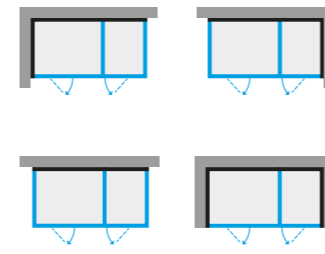

# One S

**DIMENSIONI**  
CM 214 X 171 X 226 H

**POTENZA ASSORBITA**  
6,0 KW MAX  
230 VAC 1N 50-60 HZ  
400 VAC 3N 50-60 HZ

**FINITURE**  
ALLUMINIO VERNICIATO;  
PARETI ESTERNE A VISTA GRES  
LAMINATO 3,5 MM.

**MATERIALI SAUNA**  
INTERNO ED ARREDI:  
HEMLOCK CANADESE;  
PORTE IN VETRO TEMPERATO 8 MM;  
PEDANA: GRES LAMINATO 3,5 MM  
ACCOPPIATO SU VETRO TEMPERATO  
15 MM.

**SAUNA COMPLETA DI:**  
PANCHE IN LEGNO;  
STUFA CON PIETRE;  
PANNELLO DI CONTROLLO TOUCH;  
FUNZIONE ENERGY SAVER AUTOMATICA;  
MASTELLINO INTEGRATO NELLA PANCA  
INFERIORE;  
MESTOLO IN LEGNO;  
CLESSIDRA.  
IMPIANTO ELETTRICO CANALIZZATO;  
ILLUMINAZIONE CON CROMOTERAPIA  
A LED RGB, 5 COLORI FISSI, 4 CICLI  
DINAMICI E LUCE BIANCA.

**ECC - EFFEGIBI COMFORT CONTROL**  
IL SISTEMA È INTEGRATO CHE CONSENTE  
DI GESTIRE A DISTANZA LA SAUNA,  
SCARICANDO L'APPOSITA APP EFFEGIBI  
EXPERIENCE SUL PROPRIO TABLET  
O SMARTPHONE.

**DIMENSIONS**  
CM 214 X 171 X 226 H

**ABSORBED POWER**  
6.0 KW MAX  
230 VAC 1N 50-60 HZ  
400 VAC 3N 50-60 HZ

**OUTSIDE WALL FINISH**  
PAINTED ALUMINIUM;  
OUTSIDE WALL FINISH LAMINATED  
GRÈS PORCELAIN 3.5 MM.

**SAUNA MATERIALS**  
INSIDE AND FITTINGS:  
CANADIAN HEMLOCK.  
DOORS IN 8 MM TEMPERED GLASS.  
PLATFORM: 3.5 MM LAMINATED  
GRES PORCELAIN FITTED TO 15 MM  
TOUGHENED GLASS.

**SAUNA INCLUDES:**  
WOODEN BENCHES;  
HEATER WITH STONES;  
TOUCH CONTROL PANEL;  
AUTOMATIC ENERGY SAVING FUNCTION;  
BUCKET BUILT INTO THE LOWER BENCH;  
WOODEN LADLE;  
HOURGLASS.  
ELECTRICAL SYSTEM WITH PROTECTED  
CABLE DUCTS;  
LIGHTING SYSTEM WITH LED RGB  
COLOUR THERAPY, 5 FIXED COLOURS AND  
4 DYNAMIC CYCLES AND WHITE LIGHT.

**ECC - EFFEGIBI COMFORT CONTROL**  
THIS SYSTEM IS INCORPORATED SO  
THAT THE SAUNA CAN BE REMOTELY  
CONTROLLED, JUST DOWNLOAD THE APP  
EFFEGIBI EXPERIENCE TO YOUR TABLET  
OR SMARTPHONE.

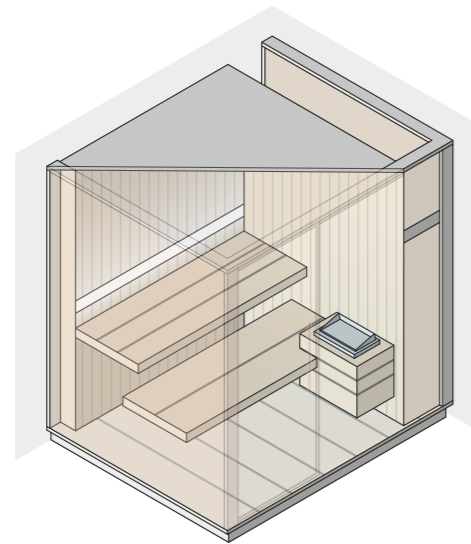
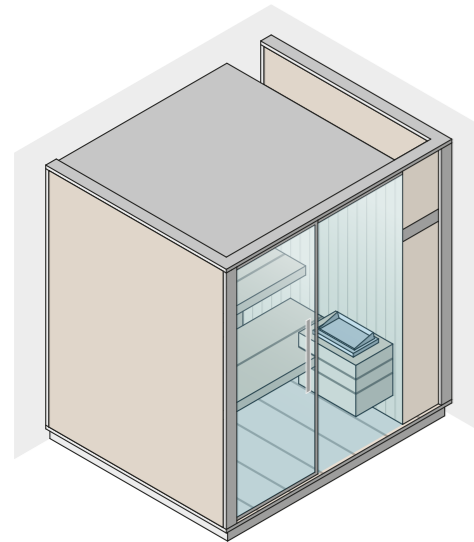

CONFIGURATIONS,  
EXAMPLES(\*):

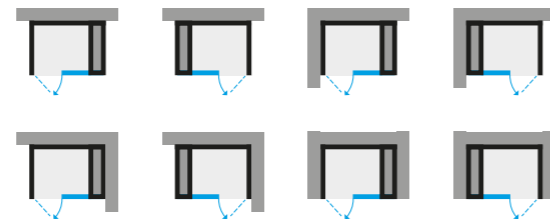

# One H

**DIMENSIONI**  
CM 214 X 171 X 226 H

**POTENZA ASSORBITA**  
4,5 KW MAX  
230 VAC 1N 50-60 HZ  
400 VAC 3N 50-60 HZ

**FINITURE**  
ALLUMINIO VERNICIATO;  
PARETI ESTERNE A VISTA GRES  
LAMINATO 3,5 MM.

**MATERIALI HAMMAM**  
INTERNO ED ARREDI:  
GRES LAMINATO 3,5 MM  
PORTE IN VETRO TEMPERATO 8 MM  
PEDANA: GRES LAMINATO 3,5 MM  
ACCOPPIATO SU VETRO TEMPERATO  
15 MM.

**HAMMAM COMPLETO DI:**  
AQUASTEAM 45;  
PANCHE IN GRES LAMINATO;  
ILLUMINAZIONE CON CROMOTERAPIA  
A LED RGB, 5 COLORI FISSI, 4 CICLI  
DINAMICI E LUCE BIANCA.

**ECC - EFFEGIBI COMFORT CONTROL**  
IL SISTEMA È INTEGRATO CHE  
CONSENTE DI GESTIRE A DISTANZA  
IL BAGNO TURCO, SCARICANDO  
L'APPOSITA APP EFFEGIBI EXPERIENCE  
SUL PROPRIO TABLET O SMARTPHONE

**DIMENSIONS**  
CM 214 X 171 X 226 H

**ABSORBED POWER**  
4.5 KW MAX  
230 VAC 1N 50-60 HZ  
400 VAC 3N 50-60 HZ

**OUTSIDE WALL FINISH**  
PAINTED ALUMINIUM;  
OUTSIDE WALL FINISH LAMINATED  
GRÈS PORCELAIN 3.5 MM.

**HAMMAM MATERIALS**  
INSIDE AND FITTINGS: 3.5 MM  
LAMINATED GRES PORCELAIN;  
DOORS IN 8 MM TEMPERED GLASS  
PLATFORM: 3.5MM LAMINATED  
GRES PORCELAIN FITTED TO 15 MM  
TOUGHENED GLASS.

**HAMMAM INCLUDES:**  
AQUASTEAM 45;  
UNGLAZED PORCELAIN TILE BENCHES;  
LIGHTING SYSTEM WITH LED RGB  
COLOUR THERAPY, 5 FIXED COLOURS,  
4 DYNAMIC CYCLES AND WHITE LIGHT.  
AUDIO SET-UP WITH BUILT-IN SPEAKERS  
AND ESS-EFFEGIBI SOUND SYSTEM.

**ECC - EFFEGIBI COMFORT CONTROL**  
THIS SYSTEM IS INCORPORATED SO THAT  
THE TURKISH BATH CAN BE REMOTELY  
CONTROLLED, JUST DOWNLOAD THE APP  
EFFEGIBI EXPERIENCE TO YOUR TABLET  
OR SMARTPHONE.

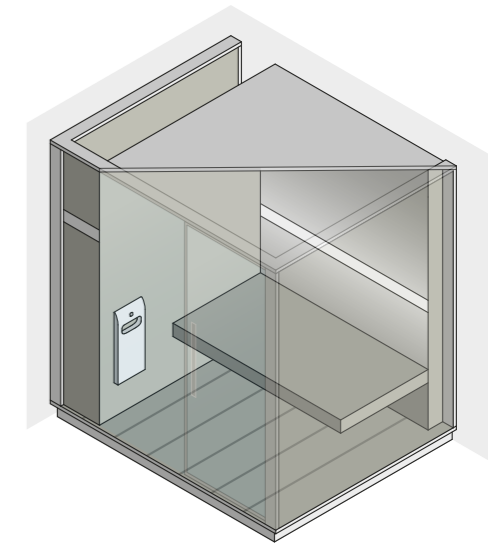
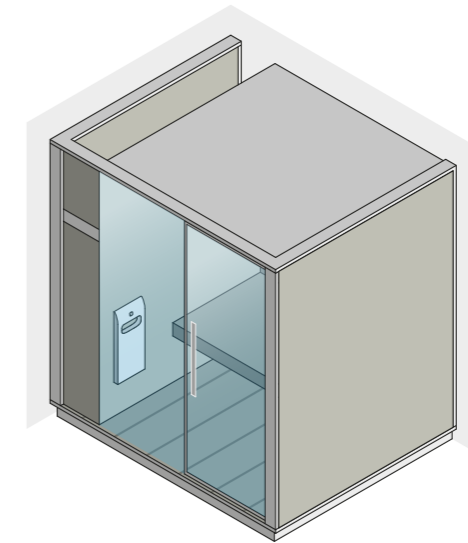

CONFIGURATIONS,  
EXAMPLES(\*):

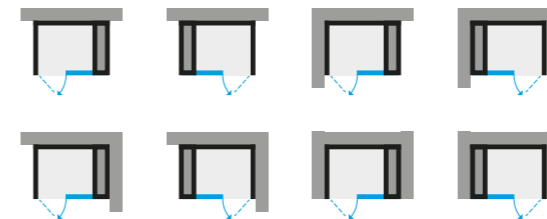

# Sky Corner

## DIMENSIONI E POTENZA ASSORBITA

SKY CORNER 80:  
CM 200 X 180 X 201 H  
SAUNA 8,0 KW MAX  
BIOSAUNA 9,0 KW MAX

SKY CORNER 60:  
CM 200 X 150 X 201 H  
SAUNA 6,0 KW MAX  
BIOSAUNA 6,0 KW MAX

SKY CORNER 45:  
CM 170 X 130 X 201 H  
SAUNA 4,5 KW MAX  
BIOSAUNA 4,5 KW MAX

SKY CORNER 36:  
CM 130 X 130 X 201 H  
SAUNA 3,6 KW MAX  
BIOSAUNA 4,5 KW MAX

## MATERIALI

ESTERNO, INTERNO ED ARREDI:  
HEMLOCK CANADESE;  
VETRI TEMPERATI CHIARI 10 MM.

## CARATTERISTICHE/COMPONENTI

ILLUMINAZIONE A PARETE CON LUCE  
BIANCA A LED;  
STUFA CON PIETRE;  
PANNELLO DI CONTROLLO  
FINITURA ACCIAIO SPAZZOLATO;  
FUNZIONE ENERGY SAVER AUTOMATICA;  
IMPIANTO ELETTRICO CANALIZZATO;  
PANCHE;  
GRIGLIA PROTEZIONE STUFA;  
MASTELLINO E MESTOLO IN LEGNO;  
CLESSIDRA.

## OPTIONAL

BIOSAUNA;  
CROMOTERAPIA A LED;  
MOOD LIGHT (LED SOTTOPANCA);  
ECC-EFFEGIBI COMFORT CONTROL;  
ESS-EFFEGIBI SOUND SYSTEM;  
PEDANE A PAVIMENTO.

## DIMENSIONS AND ABSORBED POWER

SKY CORNER 80:  
CM 200 X 180 X 201 H  
SAUNA 8,0 KW MAX  
BIOSAUNA 9,0 KW MAX

SKY CORNER 60:  
CM 200 X 150 X 201 H  
SAUNA 6,0 KW MAX  
BIOSAUNA 6,0 KW MAX

SKY CORNER 45:  
CM 170 X 130 X 201 H  
SAUNA 4,5 KW MAX  
BIOSAUNA 4,5 KW MAX

SKY CORNER 36:  
CM 130 X 130 X 201 H  
SAUNA 3,6 KW MAX  
BIOSAUNA 4,5 KW MAX

## MATERIALS

OUTSIDE, INSIDE AND FITTINGS:  
CANADIAN HEMLOCK;  
10 MM CLEAR TEMPERED GLASS.

## FEATURES/COMPONENTS

WALL LIGHTING WITH LED WHITE LIGHT;  
HEATER WITH STONES;  
CONTROL PANEL WITH BRUSHED STEEL  
FINISH;  
AUTOMATIC ENERGY SAVER FUNCTION;  
ELECTRICAL SYSTEM WITH PROTECTED  
CABLE DUCTS;  
BENCHES;  
PROTECTIVE GRILLE FOR HEATER;  
WOODEN BUCKET AND LADLE;  
HOURGLASS.

## OPTIONAL

BIOSAUNA;  
COLOUR THERAPY LED RGB;  
MOOD LIGHT (LED UNDER THE BENCH);  
ECC-EFFEGIBI COMFORT CONTROL;  
ESS-EFFEGIBI SOUND SYSTEM;  
FLOOR PLATFORMS.

CONFIGURATIONS,  
EXAMPLES(\*):

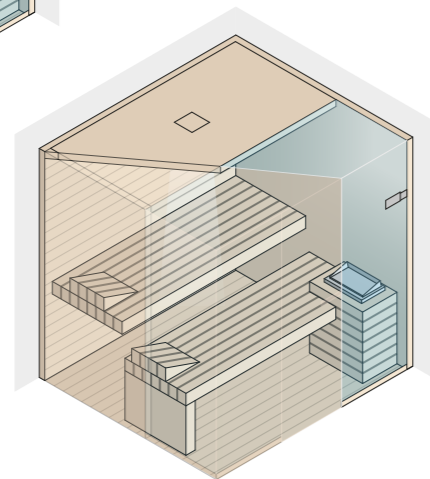
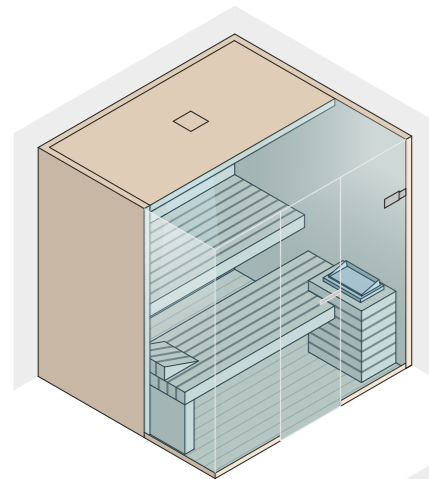

# Sky

## DIMENSIONI E POTENZA ASSORBITA

SKY 80:  
CM 200 X 180 X 201 H  
SAUNA 8,0 KW MAX  
BIOSAUNA 9,0 KW MAX

SKY 60:  
CM 200 X 150 X 201 H  
SAUNA 6,0 KW MAX  
BIOSAUNA 6,0 KW MAX

SKY 40:  
CM 170 X 130 X 201 H  
SAUNA 4,0 KW MAX  
BIOSAUNA 4,5 KW MAX

SKY 30:  
CM 130 X 130 X 201 H  
SAUNA 3,0 KW MAX  
BIOSAUNA 3,0 KW MAX

## MATERIALI

ESTERNO, INTERNO ED ARREDI:  
HEMLOCK CANADESE;  
VETRI TEMPERATI CHIARI 10 MM.

## CARATTERISTICHE/COMPONENTI

ILLUMINAZIONE A PARETE CON LUCE  
BIANCA A LED;  
STUFA CON PIETRE;  
PANNELLO DI CONTROLLO FINITURA  
ACCIAIO SPAZZOLATO;  
FUNZIONE ENERGY SAVER AUTOMATICA;  
IMPIANTO ELETTRICO CANALIZZATO;  
PANCHE;  
GRIGLIA PROTEZIONE STUFA;  
MASTELLINO E MESTOLO IN LEGNO;  
CLESSIDRA.

## OPTIONAL

BIOSAUNA;  
CROMOTERAPIA A LED;  
MOOD LIGHT (LED SOTTOPANCA);  
ECC-EFFEGIBI COMFORT CONTROL;  
ESS-EFFEGIBI SOUND SYSTEM;  
PEDANE A PAVIMENTO.

## DIMENSIONS E ABSORBED POWER

SKY 80:  
CM 200 X 180 X 201 H  
SAUNA 8,0 KW MAX  
BIOSAUNA 9,0 KW MAX

SKY 60:  
CM 200 X 150 X 201 H  
SAUNA 6,0 KW MAX  
BIOSAUNA 6,0 KW MAX

SKY 40:  
CM 170 X 130 X 201 H  
SAUNA 4,0 KW MAX  
BIOSAUNA 4,5 KW MAX

SKY 30:  
CM 130 X 130 X 201 H  
SAUNA 3,0 KW MAX  
BIOSAUNA 3,0 KW MAX

## MATERIALS

OUTSIDE, INSIDE AND FITTINGS:  
CANADIAN HEMLOCK;  
10 MM CLEAR TEMPERED GLASS.

## FEATURES/COMPONENTS

WALL LIGHTING WITH LED WHITE LIGHT;  
HEATER WITH STONES;  
CONTROL PANEL WITH BRUSHED STEEL  
FINISH;  
AUTOMATIC ENERGY SAVER FUNCTION;  
ELECTRICAL SYSTEM WITH PROTECTED  
CABLE DUCTS;  
BENCHES;  
PROTECTIVE GRILLE FOR HEATER;  
WOODEN BUCKET AND LADLE;  
HOURGLASS.

## OPTIONAL

BIOSAUNA;  
COLOUR THERAPY LED RGB;  
MOOD LIGHT (LED UNDER THE BENCH);  
ECC-EFFEGIBI COMFORT CONTROL;  
ESS-EFFEGIBI SOUND SYSTEM;  
FLOOR PLATFORMS.

CONFIGURATIONS,  
EXAMPLES(\*):

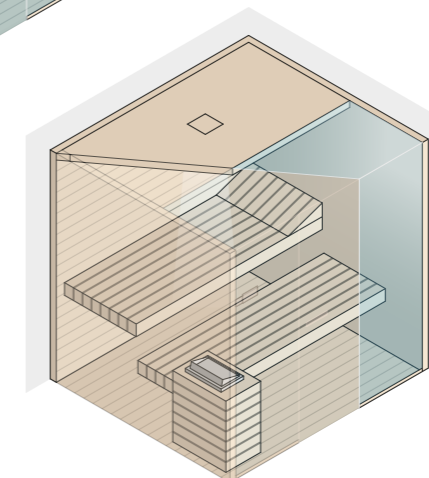
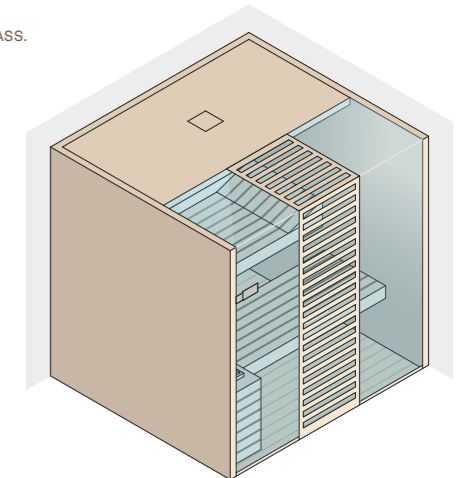
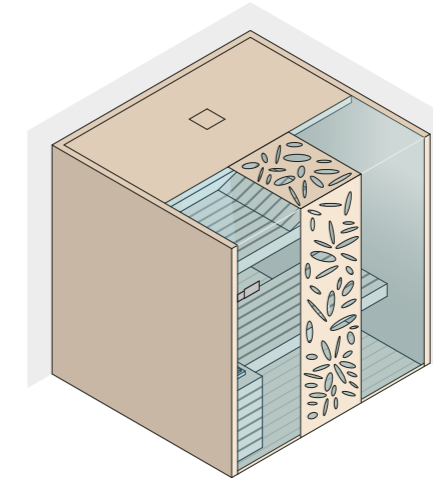
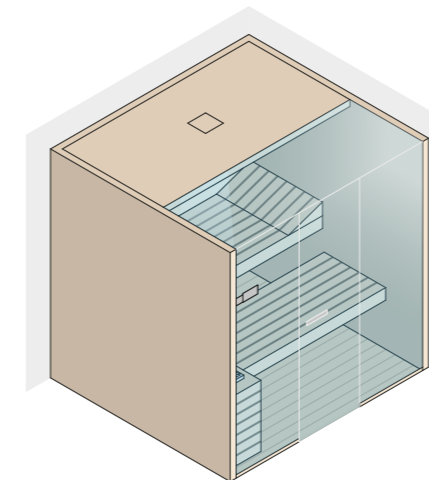
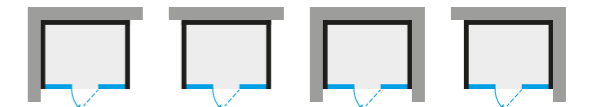

# Air

**DIMENSIONI E POTENZA ASSORBITA**

AIR 120:  
CM 283 X 252 X 213 H  
SAUNA 12,0 KW MAX  
BIOASAUNA 12,0 KW MAX

AIR 80:  
CM 247 X 182 X 213 H  
SAUNA 8,0 KW MAX  
BIOASAUNA 9,0 KW MAX

AIR 60:  
CM 217 X 162 X 213 H  
SAUNA 6,0 KW MAX  
BIOASAUNA 6,0 KW MAX

AIR 105 CORNER:  
CM 247 X 182 X 213 H  
SAUNA 10,5 KW MAX  
BIOASAUNA 10,5 KW MAX

AIR 80 CORNER:  
CM 217 X 162 X 213 H  
SAUNA 8,0 KW MAX  
BIOASAUNA 9,0 KW MAX

**MATERIALI**

ESTERNO, INTERNO: TECK - TULIPIER;  
ARREDI: ASPEN NATURALE - ASPEN  
TERMOTRATTATO;  
VETRI TEMPERATI CHIARI 10 MM.

**CARATTERISTICHE/COMPONENTI**

ILLUMINAZIONE A PARETE CON LUCE  
BIANCA A LED;  
STUFA CON PIETRE;  
PANNELLO DI CONTROLLO, FINITURA  
ACCIAIO SPAZZOLATO;  
FUNZIONE ENERGY SAVER AUTOMATICA;  
IMPIANTO ELETTRICO CANALIZZATO;  
PANCHE;  
GRIGLIA PROTEZIONE STUFA;  
MASTELLINO E MESTOLO IN LEGNO;  
CLESSIDRA.

**OPTIONAL**

BIOASAUNA;  
CROMOTERAPIA A LED;  
MOOD LIGHT (LED SOTTOPANCA);  
ECC-EFFEGIBI COMFORT CONTROL;  
ESS-EFFEGIBI SOUND SYSTEM;  
PORTASCIUGAMANI E MENSOLA.

**DIMENSIONS AND ABSORBED POWER**

AIR 120:  
CM 283 X 252 X 213 H  
SAUNA 12.0 KW MAX  
BIOASAUNA 12.0 KW MAX

AIR 80:  
CM 247 X 182 X 213 H  
SAUNA 8.0 KW MAX  
BIOASAUNA 9.0 KW MAX

AIR 60:  
CM 217 X 162 X 213 H  
SAUNA 6.0 KW MAX  
BIOASAUNA 6.0 KW MAX

AIR 105 CORNER:  
CM 247 X 182 X 213 H  
SAUNA 10.5 KW MAX  
BIOASAUNA 10.5 KW MAX

AIR 80 CORNER:  
CM 217 X 162 X 213 H  
SAUNA 8.0 KW MAX  
BIOASAUNA 9.0 KW MAX

**MATERIALS**

OUTSIDE, INSIDE: TECK - TULIPIER;  
FITTINGS: NATURAL ASPEN WOOD -  
HEAT-TREATED ASPEN WOOD;  
10 MM CLEAR TEMPERED GLASS.

**FEATURES/COMPONENTS**

WALL LIGHTING WITH LED WHITE LIGHT;  
HEATER WITH STONES;  
CONTROL PANEL WITH BRUSHED STEEL  
FINISH;  
AUTOMATIC ENERGY SAVER FUNCTION;  
ELECTRICAL SYSTEM WITH PROTECTED  
CABLE DUCTS;  
BENCHES;  
PROTECTIVE GRILLE FOR HEATER;  
WOODEN BUCKET AND LADLE;  
HOURGLASS.

**OPTIONAL**

BIOASAUNA;  
COLOUR THERAPY LED RGB;  
MOOD LIGHT (LED UNDER THE BENCH);  
ECC-EFFEGIBI COMFORT CONTROL;  
ESS-EFFEGIBI SOUND SYSTEM;  
TOWEL HOLDER AND SHELF.

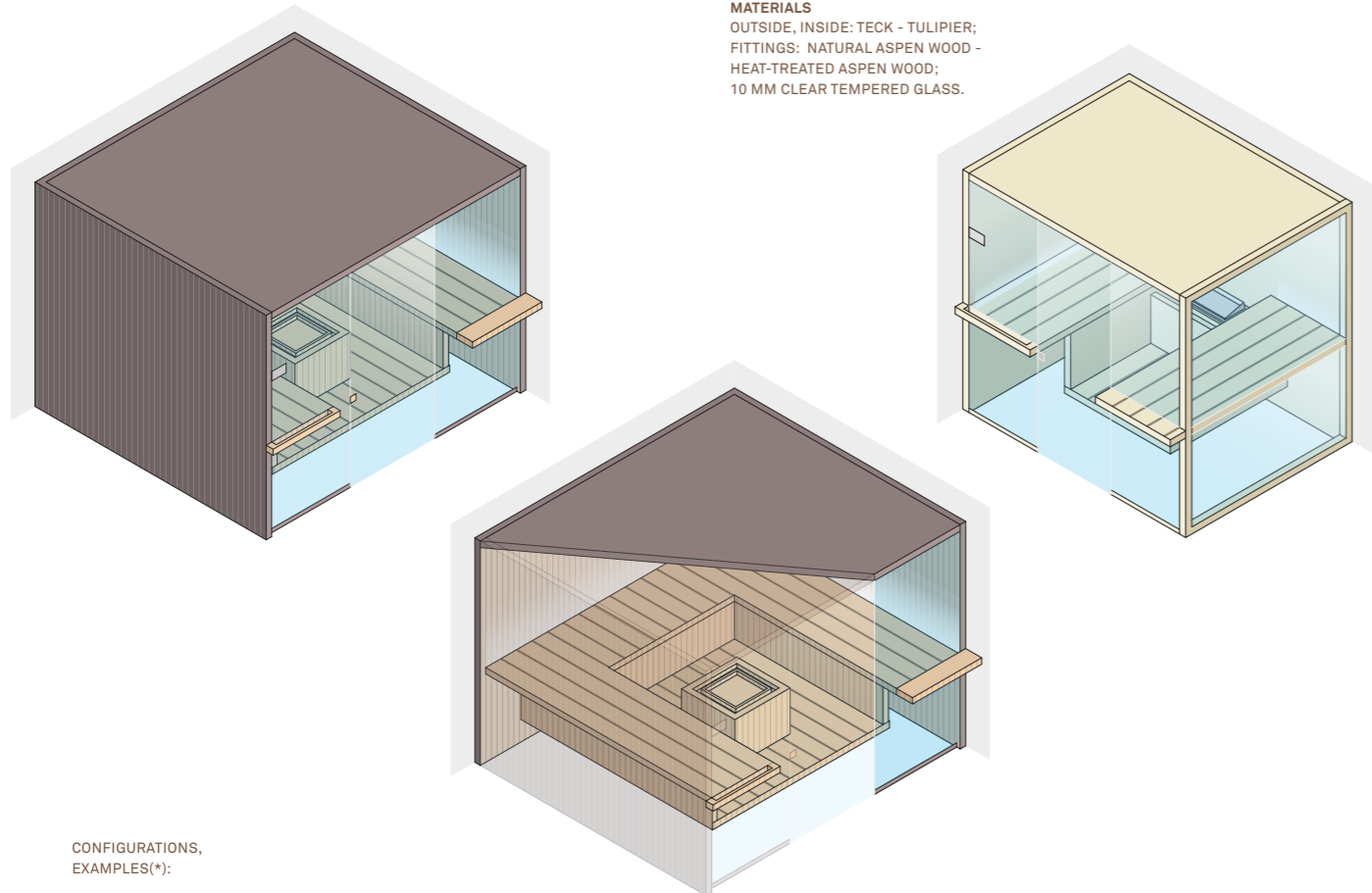

CONFIGURATIONS,  
EXAMPLES(\*):

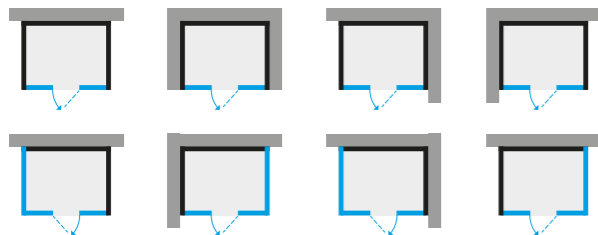

# Gym

**DIMENSIONI E POTENZA ASSORBITA**

GYM 300:  
CM 300 X 200 X 216 H  
SAUNA 8,0 KW MAX  
BIOASAUNA 9,0 KW MAX

GYM 250:  
CM 250 X 200 X 216 H  
SAUNA 8,0 KW MAX  
BIOASAUNA 9,0 KW MAX

GYM 200:  
CM 200 X 150 X 216 H  
SAUNA 6,0 KW MAX  
BIOASAUNA 6,0 KW MAX

**MATERIALI**

ESTERNO, INTERNO ED ARREDI:  
HEMLOCK CANADESE;  
VETRI TEMPERATI CHIARI 8 MM.

**CARATTERISTICHE/COMPONENTI**

ILLUMINAZIONE A PARETE CON LUCE  
BIANCA A LED;  
STUFA CON PIETRE;  
PANNELLO DI CONTROLLO, FINITURA  
ACCIAIO SPAZZOLATO;  
FUNZIONE ENERGY SAVER AUTOMATICA;  
IMPIANTO ELETTRICO CANALIZZATO;  
STRUTTURA E PARETI RINFORZATE;  
PANCHE E PROTEZIONI FACILMENTE  
REMOVIBILI PER AGEVOLAZIONE  
OPERAZIONI DI PULIZIA;  
BASE PERIMETRALE A TERRA IN  
ALLUMINIO;  
GRIGLIA PROTEZIONE STUFA CON  
MASTELLINO INTEGRATO;  
MESTOLO IN LEGNO;  
POGGIASCHIENA ERGONOMICO  
LUNGO LA PARETE POSTERIORE;  
CLESSIDRA;

**OPTIONAL**

BIOASAUNA;  
CROMOTERAPIA A LED;  
MOOD LIGHT (LED SOTTOPANCA);  
ECC-EFFEGIBI COMFORT CONTROL;  
ESS-EFFEGIBI SOUND SYSTEM;  
PEDANE A PAVIMENTO.

**DIMENSIONS AND ABSORBED POWER**

GYM 300:  
CM 300 X 200 X 216 H  
SAUNA 8.0 KW MAX  
BIOASAUNA 9.0 KW MAX

GYM 250:  
CM 250 X 200 X 216 H  
SAUNA 8.0 KW MAX  
BIOASAUNA 9.0 KW MAX

GYM 200:  
CM 200 X 150 X 216 H  
SAUNA 6.0 KW MAX  
BIOASAUNA 6.0 KW MAX

**MATERIALS**

OUTSIDE, INSIDE AND FITTINGS:  
CANADIAN HEMLOCK;  
8 MM CLEAR TEMPERED GLASS.

**FEATURES/COMPONENTS**

WALL LIGHTING WITH LED WHITE LIGHT;  
HEATER WITH STONES;  
CONTROL PANEL WITH BRUSHED STEEL  
FINISH;  
AUTOMATIC ENERGY SAVER FUNCTION;  
ELECTRICAL SYSTEM WITH PROTECTED  
CABLE DUCTS;  
REINFORCED FRAMEWORK AND WALLS;  
EASILY REMOVABLE BENCHES AND  
PROTECTIVE FEATURES FACILITATE  
CLEANING OPERATIONS;  
ALUMINIUM BASE FRAME;  
PROTECTIVE GRILLE FOR HEATER WITH  
BUILT IN WOODEN BUCKET AND LADLE;  
ERGONOMIC BACKREST ALONG THE  
BACK WALL;  
HOURGLASS.

**OPTIONS**

BIOASAUNA;  
COLOUR THERAPY LED RGB;  
MOOD LIGHT (LED UNDER THE BENCH);  
ECC-EFFEGIBI COMFORT CONTROL;  
ESS-EFFEGIBI SOUND SYSTEM;  
FLOOR PLATFORMS.

CONFIGURATIONS,  
EXAMPLES(\*):

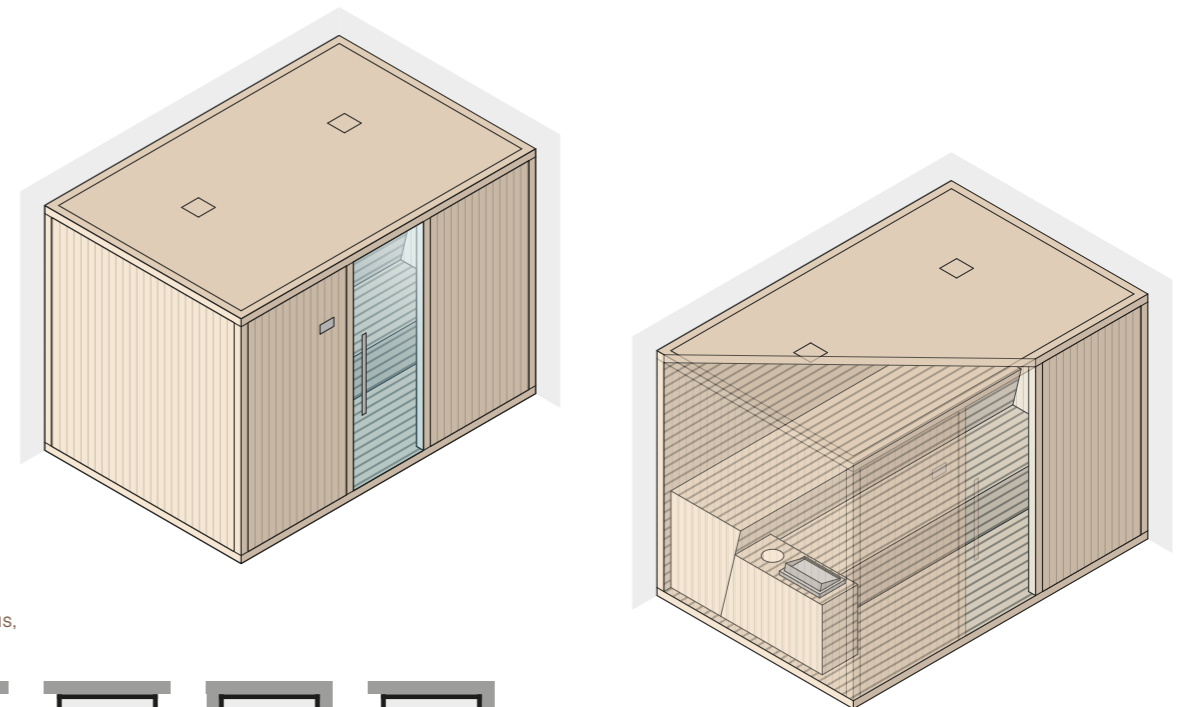

(\*)  
OTHER LAYOUTS CAN BE SEEN  
ON THE EFFEGIBI WEBSITE: WWW.EFFEGIBI.IT

# Auki

## DIMENSIONI E POTENZA ASSORBITA

AUKI 60:  
CM 228 X 170 X 201 H  
SAUNA 6,0 KW MAX  
BIO SAUNA 6,0 KW MAX

AUKI 45:  
CM 202 X 152 X 201 H  
SAUNA 4,5 KW MAX  
BIO SAUNA 4,5 KW MAX

AUKI 36:  
CM 189 X 126 X 201 H  
SAUNA 3,6 KW MAX  
BIO SAUNA 4,5 KW MAX

AUKI 25:  
CM 128 X 126 X 201 H  
SAUNA 2,5 KW MAX  
BIO SAUNA 2,5 KW MAX

## MATERIALI

ESTERNO, INTERNO ED ARREDI:  
HEMLOCK CANADESE OPPURE  
ABETE DI SVEZIA;  
VETRI TEMPERATI CHIARI 8 MM.

## CARATTERISTICHE/COMPONENTI

ILLUMINAZIONE A PARETE CON LUCE  
BIANCA A LED;  
STUFA CON PIETRE;  
PANNELLO DI CONTROLLO, FINITURA  
ACCIAIO SPAZZOLATO;  
FUNZIONE ENERGY SAVER AUTOMATICA;  
IMPIANTO ELETTRICO CANALIZZATO;  
PANCHE;  
GRIGLIA PROTEZIONE STUFA;  
MASTELLINO E MESTOLO IN LEGNO;  
CLESSIDRA.

## OPTIONAL

BIO SAUNA;  
CROMOTERAPIA A LED;  
MOOD LIGHT (LED SOTTOPANCA);  
ECC-EFFEGIBI COMFORT CONTROL;  
ESS-EFFEGIBI SOUND SYSTEM;  
PEDANE A PAVIMENTO.

## DIMENSIONS E ABSORBED POWER

AUKI 60:  
CM 228 X 170 X 201 H  
SAUNA 6.0 KW MAX  
BIO SAUNA 6.0 KW MAX

AUKI 45:  
CM 202 X 152 X 201 H  
SAUNA 4.5 KW MAX  
BIO SAUNA 4.5 KW MAX

AUKI 36:  
CM 189 X 126 X 201 H  
SAUNA 3.6 KW MAX  
BIO SAUNA 4.5 KW MAX

AUKI 25:  
CM 128 X 126 X 201 H  
SAUNA 2.5 KW MAX  
BIO SAUNA 2.5 KW MAX

## MATERIALS

OUTSIDE, INSIDE AND FITTINGS:  
CANADIAN HEMLOCK  
OR SWEDISH FIR WOOD;  
8 MM CLEAR TEMPERED GLASS.

## FEATURES/COMPONENTS

WALL LIGHTING WITH LED WHITE LIGHT;  
HEATER WITH STONES;  
CONTROL PANEL WITH BRUSHED STEEL  
FINISH;  
AUTOMATIC ENERGY SAVER FUNCTION;  
ELECTRICAL SYSTEM WITH PROTECTED  
CABLE DUCTS;  
BENCHES;  
PROTECTIVE GRILLE FOR HEATER;  
WOODEN BUCKET AND LADLE;  
HOURGLASS.

## OPTIONAL

BIO SAUNA;  
COLOUR THERAPY LED RGB;  
MOOD LIGHT (LED UNDER THE BENCH);  
ECC-EFFEGIBI COMFORT CONTROL;  
ESS-EFFEGIBI SOUND SYSTEM;  
FLOOR PLATFORMS.

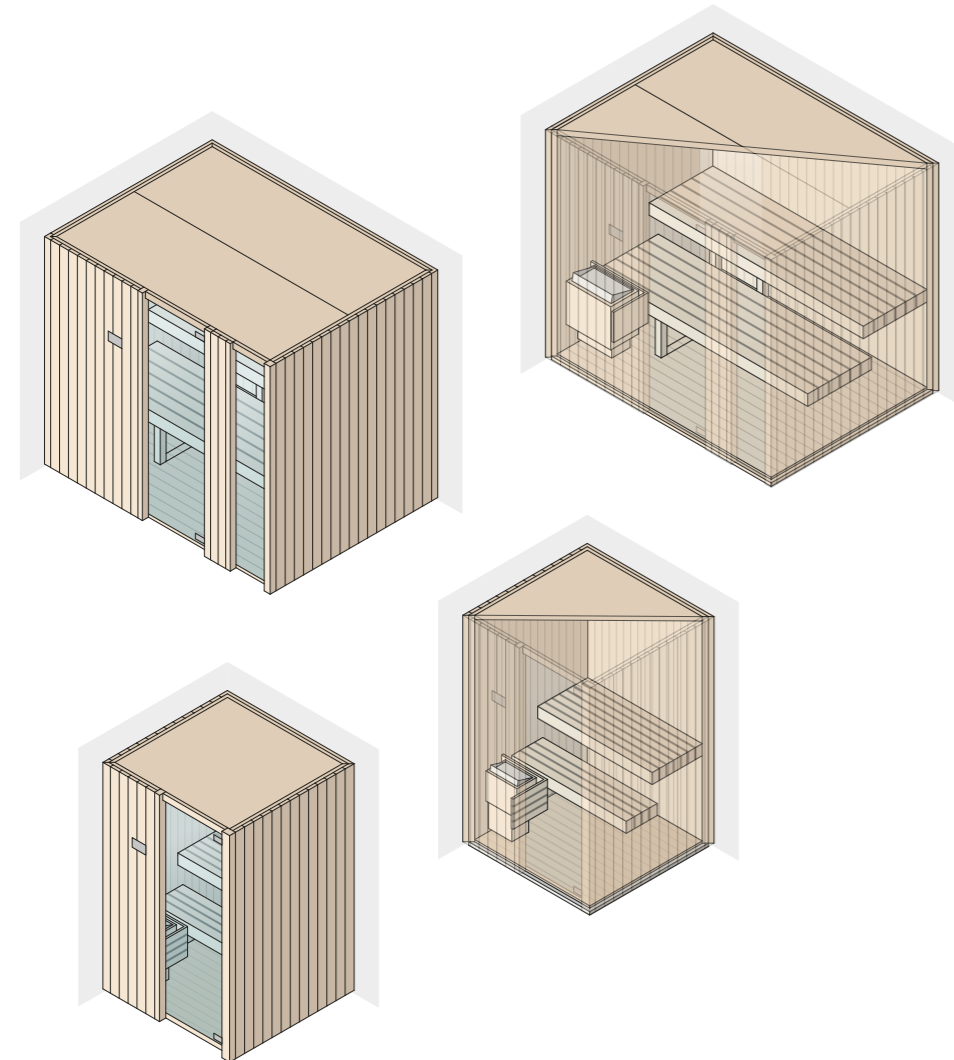

# H

## DIMENSIONI E POTENZA ASSORBITA

LARGE:  
CM 173 X 102 X 220 H  
4,5 KW MAX

MEDIUM:  
CM 152 X 102 X 220 H  
3,0 KW MAX

SMALL:  
CM 131 X 92 X 220 H  
3,0 KW MAX

## FINITURE

ALLUMINIO VERNICIATO;  
PARETI ESTERNE A VISTA GRES  
LAMINATO 3,5 MM.

## MATERIALI HAMMAM - DOCCIA

INTERNO: GRES LAMINATO 3,5 MM;  
PORTE IN VETRO TEMPERATO 8 MM.  
ARREDI E PEDANA: GRES LAMINATO 3,5  
MM ACCOPPIATO SU VETRO TEMPERATO  
15 MM.

## HAMMAM COMPLETO DI:

AQUASTEAM;  
PANCHE IN GRES LAMINATO;  
ILLUMINAZIONE CON CROMOTERAPIA  
A LED RGB, 5 COLORI FISSI, 4 CICLI  
DINAMICI E LUCE BIANCA.

## DOCCIA COMPLETA DI:

MISCELATORE TERMOSTATICO  
CON DEVIATORE A 3 VIE;  
DOCCIA A MANO;  
SOFFIONE DOCCIA A SOFFITTO  
42 X 42 CM CON FUNZIONI PIOGGIA  
E NEBULIZZAZIONE.

## DIMENSIONS AND ABSORBED POWER

LARGE:  
CM 173 X 102 X 220 H  
4.5 KW MAX

MEDIUM:  
CM 152 X 102 X 220 H  
3.0 KW MAX

SMALL:  
CM 131 X 92 X 220 H  
3.0 KW MAX

## OUTSIDE WALL FINISH

PAINTED ALUMINIUM;  
OUTSIDE WALL FINISH LAMINATED  
GRÈS PORCELAIN 3.5 MM.

## HAMMAM - SHOWER MATERIALS

INSIDE:  
3.5 MM LAMINATED GRES PORCELAIN;  
DOORS IN 8 MM TEMPERED GLASS.  
FITTINGS AND PLATFORM: 3.5 MM  
LAMINATED GRES PORCELAIN FITTED TO  
15 MM TOUGHENED GLASS

## HAMMAM INCLUDES:

AQUASTEAM;  
UNGLAZED PORCELAIN TILE BENCHES;  
LIGHTING SYSTEM WITH LED RGB  
COLOUR THERAPY, 5 FIXED COLOURS,  
4 DYNAMIC CYCLES AND WHITE LIGHT.

## SHOWER INCLUDES:

THERMOSTATIC MIXER WITH 3-WAY  
DIVERTER;  
HAND-HELD SHOWER HEAD;  
42 X 42 CM CEILING-MOUNTED SHOWER  
HEAD WITH RAIN AND NEBULISER  
FUNCTIONS.

## CONFIGURATIONS, EXAMPLES(\*):

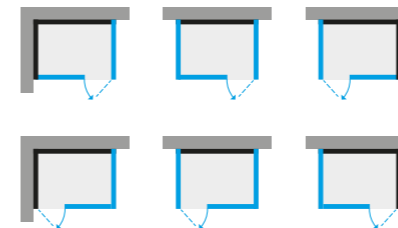

## CONFIGURATIONS, EXAMPLES(\*):

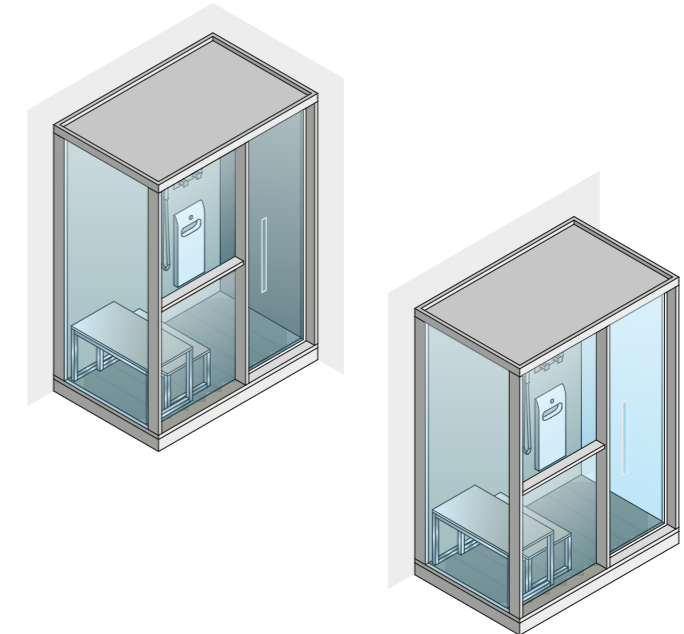
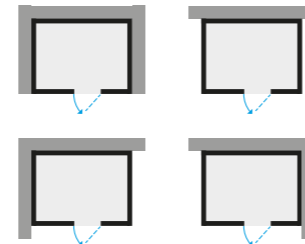

# Topkapi

## DIMENSIONI E POTENZA ASSORBITA

190X130:  
CM 193,2 X 130 X 219,5 H  
4,5 KW MAX

190X90:  
CM 153,2 X 90 X 219,5 H  
3,0 KW MAX

150X130:  
CM 153,2 X 130 X 219,5 H  
4,5 KW MAX

150X90:  
CM 153,2 X 90 X 219,5 H  
3,0 KW MAX

## RIVESTIMENTI INTERNI

MARMO CARRARA;  
MARMO BOTTICINO;  
MARMO MARQUINA.

## VETRATE DI FONDO

VETRO TEMPERATO SERIGRAFATO  
CON SMALTO CERAMICO BIANCO;  
VETRO TEMPERATO FINITURA  
A SPECCHIO.

## VETRATE A VISTA

VETRO CAMERA TEMPERATO 25 MM  
NELLE FINITURE:  
RAIN, TRASPARENTE.

## CARATTERISTICHE/COMPONENTI

GENERATORE DI VAPORE INTERNO  
ALLA COLONNINA;  
FONTE CON CIOTOLA IN ACCIAIO,  
FINITURA RAMATA;  
PANCA IN TECK DELLA BIRMANIA  
AL NATURALE CON STRUTTURA  
IN ACCIAIO INOX;  
CROMOTERAPIA A LED RGB, 5 COLORI  
FISSI, 4 CICLI DINAMICI  
LUCE BIANCA A LED;  
MISCELATORE CON CARTUCCIA  
PROGRESSIVA E DEVIATORE;  
SOFFIONE DOCCIA A SOFFITTO  
CON ANTICALCARE;  
DOCCIA A MANO.

## ECC - EFFEGIBI COMFORT CONTROL

IL SISTEMA È INTEGRATO IN OGNI  
GENERATORE DI VAPORE EFFEGIBI E  
CONSENTE DI GESTIRE A DISTANZA IL  
BAGNO TURCO, SCARICANDO L'APPOSITA  
APP EFFEGIBI EXPERIENCE SUL PROPRIO  
TABLET O SMARTPHONE.

## ESS - EFFEGIBI SOUND SYSTEM

ATTRAVERSO LA DOCKING STATION IN  
DOTAZIONE È POSSIBILE COLLEGARE IL  
PROPRIO DISPOSITIVO (SMARTPHONE,  
TABLET, ETC.) E ASCOLTARE LA PROPRIA  
MUSICA PREFERITA.

## DIMENSIONS AND ABSORBED POWER

190X130:  
CM 193.2 X 130 X 219.5 H  
4.5 KW MAX

190X90:  
CM 153.2 X 90 X 219.5 H  
3.0 KW MAX

150X130:  
CM 153.2 X 130 X 219.5 H  
4.5 KW MAX

150X90:  
CM 153.2 X 90 X 219.5 H  
3.0 KW MAX

## INTERIOR COVERINGS

CARRARA MARBLE;  
BOTTICINO MARBLE;  
MARQUINA MARBLE.

## BACK GLASS PANELS

SCREEN-PRINTED TOUGHENED  
GLASS WITH WHITE CERAMIC ENAMEL;  
MIRROR-FINISH TOUGHENED GLASS.

## GLASS PANELS ON VIEW

25 MM DOUBLE-GLAZED TOUGHENED  
GLASS:  
RAIN, TRANSPARENT.

## FEATURES/COMPONENTS

STEAM GENERATOR INSIDE THE  
COLUMN;  
SPRING WITH COPPER-FINISH STEEL  
BOWL;  
BENCH WITH NATURAL-FINISH BURMESE  
TEAK SEAT AND STAINLESS STEEL  
SUPPORT;  
RGB LED COLOUR THERAPY, 5 FIXED  
COLOURS, 4 DYNAMIC CYCLES  
WHITE LED LIGHT;  
MIXER TAP WITH FLOW REGULATOR AND  
DIVERTER;  
CEILING MOUNTED ANTI-SCALE SHOWER  
HEAD;  
HAND-HELD SHOWER HEAD.

## ECC - EFFEGIBI COMFORT CONTROL

THIS SYSTEM IS INCORPORATED INTO  
EVERY EFFEGIBI STEAM GENERATOR  
SO THAT THE TURKISH BATH CAN BE  
REMOTEY CONTROLLED. TO ENABLE  
IT, JUST DOWNLOAD THE APP EFFEGIBI  
EXPERIENCE TO YOUR TABLET OR  
SMARTPHONE.

## ESS - EFFEGIBI SOUND SYSTEM

THE EFFEGIBI DOCKING STATION CAN  
BE CONNECTED TO ANY TABLET OR  
SMARTPHONE SO YOU CAN LISTEN TO  
YOUR FAVOURITE MUSIC BOTH INSIDE  
AND OUTSIDE THE HAMMAM.

## CONFIGURATIONS, EXAMPLES(\*):

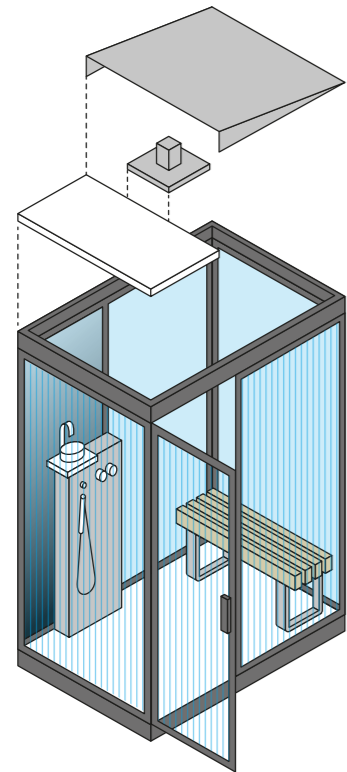

# Finishes Finiture

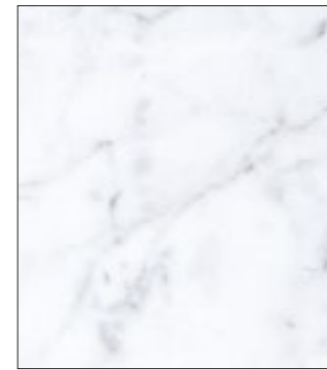

CARRARA MARBLE

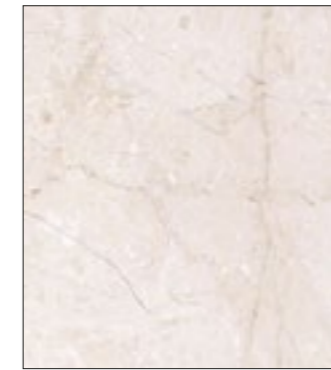

BOTTICINO MARBLE

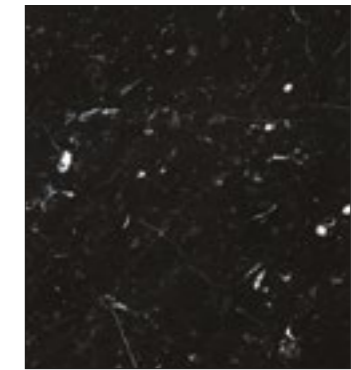

MARQUINA MARBLE

Pavimento  
e colonna  
Floor  
and column

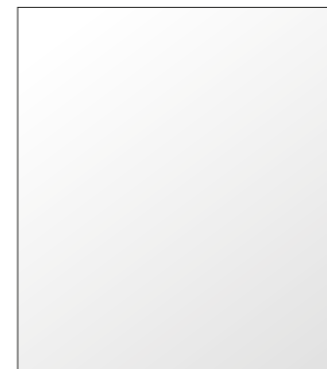

WHITE



MIRROR

Vetro  
di fondo  
Black  
glass

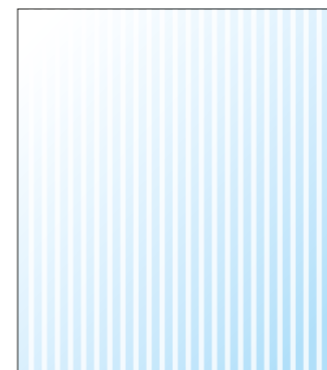

RAIN



TRANSPARENT

Vetro  
frontale  
Front  
glass

(\*)  
OTHER LAYOUTS CAN BE SEEN  
ON THE EFFEGIBI WEBSITE: WWW.EFFEGIBI.IT



# Touch&Steam

## DIMENSIONI

CM 23 X 3,7 X 165 H

## DIMENSIONI CONTROCASSA

CM 40 X 10 X 173 H

## MATERIALI

VETRO TEMPERATO SERIGRAFATO;  
ALLUMINIO VERNICIATO RAL 9003;

## COLONNA ATTREZZATA COMPLETA DI:

GENERATORE DI VAPORE INTERNO CON:  
SISTEMA AUTOMATICO DI  
LAVAGGIO CALDAIA;  
SISTEMA DI REGOLAZIONE  
PORTATA ACQUA;  
SISTEMA AUTOMATICO DI  
SCARICO ACQUA;  
FUNZIONE ENERGY SAVER AUTOMATICA;  
PANNELLO DI CONTROLLO TOUCH  
CON ICONE RETROILLUMINATE E  
INDICATORE DEL LIVELLO DI  
TEMPERATURA.

## FUNZIONE POWER STEAM:

SISTEMA DI DIFFUSIONE VAPORE  
A VENTILAZIONE FORZATA.

## FUNZIONE CALDO DOCCIA:

SISTEMA DI RISCALDAMENTO A  
VENTILAZIONE FORZATA CON  
FUNZIONE PRERISCALDAMENTO.  
VANO CONTENITORI PER ESSENZE.  
ILLUMINAZIONE CON CROMOTERAPIA  
A LED RGB, 5 COLORI FISSI, 4 CICLI  
DINAMICI E LUCE BIANCA.

## ECC - EFFEGIBI COMFORT CONTROL

IL SISTEMA È INTEGRATO IN OGNI  
GENERATORE DI VAPORE EFFEGIBI E  
CONSENTE DI GESTIRE A DISTANZA IL  
BAGNO TURCO, SCARICANDO L'APPOSITA  
APP EFFEGIBI EXPERIENCE SUL PROPRIO  
TABLET O SMARTPHONE.

## ESS - EFFEGIBI SOUND SYSTEM

ATTRAVERSO LA DOCKING STATION IN  
DOTAZIONE È POSSIBILE COLLEGARE IL  
PROPRIO DISPOSITIVO (SMARTPHONE,  
TABLET, ETC.) E ASCOLTARE LA PROPRIA  
MUSICA PREFERITA.

## DIMENSIONS

CM 23 X 3,7 X 165 H

## COUNTERBOX DIMENSIONS

CM 40 X 10 X 173 H

## MATERIALS

SCREEN-PRINTED TEMPERED GLASS  
PANEL;  
PAINTED ALUMINIUM RAL 9003;

## EQUIPPED COLUMN WITH:

BUILT IN STEAM GENERATOR;  
AUTOMATIC BOILER CLEANING SYSTEM;  
WATER FLOW RATE CONTROL SYSTEM;  
AUTOMATIC WATER DRAINAGE SYSTEM;  
AUTOMATIC ENERGY SAVER FUNCTION;  
TOUCH-SCREEN CONTROL PANEL  
WITH BACKLIT ICONS AND TEMPERATURE  
GAUGE.

## POWER STEAM FUNCTION:

STEAM DIFFUSION AND FORCED  
VENTILATION HEATING SYSTEM.

## CALDO DOCCIA FUNCTION:

UNIT PRE-HEATING FUNCTION WITH  
FORCED VENTILATION HEATING SYSTEM.  
CONTAINERS FOR ESSENTIAL OILS.  
LIGHTING SYSTEM WITH LED RGB  
COLOUR THERAPY 5 FIXED COLOURS,  
4 DYNAMIC CYCLES AND WHITE LIGHT.

## ECC - EFFEGIBI COMFORT CONTROL

THIS SYSTEM IS INCORPORATED INTO  
EVERY EFFEGIBI STEAM GENERATOR  
SO THAT THE TURKISH BATH CAN BE  
REMOTEY CONTROLLED. TO ENABLE  
IT, JUST DOWNLOAD THE APP EFFEGIBI  
EXPERIENCE TO YOUR TABLET OR  
SMARTPHONE.

## ESS - EFFEGIBI SOUND SYSTEM

THE EFFEGIBI DOCKING STATION CAN  
BE CONNECTED TO ANY TABLET OR  
SMARTPHONE SO YOU CAN LISTEN TO  
YOUR FAVOURITE MUSIC BOTH INSIDE  
AND OUTSIDE THE HAMMAM.

MODELLO MODEL TOUCH&STEAM	VOLUME VANO COMPARTMENT VOLUME (M <sup>3</sup> )	POTENZA POWER (KW)
30	0 - 3,5	3,0
45	3,5 - 4,5	4,5
60	4,5 - 6,2	6,0
90	6,2 - 9,2	9,0

# Aquasteam

## DIMENSIONI

CM 25 X 3,7 X 57 H

## DIMENSIONI CONTROCASSA

CM 37 X 10 X 54 H

## MATERIALI

VETRO CURVATO SERIGRAFATO;  
ALLUMINIO VERNICIATO RAL 9003;

## ECC - EFFEGIBI COMFORT CONTROL

IL SISTEMA È INTEGRATO NEL  
GENERATORE DI VAPORE CHE CONSENTE  
DI GESTIRE A DISTANZA IL BAGNO TURCO,  
SCARICANDO L'APPOSITA APP EFFEGIBI  
EXPERIENCE SUL PROPRIO TABLET O  
SMARTPHONE.

## GENERATORE DI VAPORE INTERNO

### CARATTERISTICHE:

SISTEMA AUTOMATICO DI  
LAVAGGIO CALDAIA;  
SISTEMA DI REGOLAZIONE  
PORTATA ACQUA;  
SISTEMA AUTOMATICO DI  
SCARICO ACQUA;  
FUNZIONE ENERGY SAVER AUTOMATICA.  
PANNELLO DI CONTROLLO TOUCH CON  
ICONE RETROILLUMINATE E INDICATORE  
DEL LIVELLO DI TEMPERATURA.  
FONTE A CADUTA CON EROGAZIONE  
ACQUA CONTROLLATA E  
RETROILLUMINATA;  
CIOTOLA IN RESINA BIANCA;  
CONTENITORI PER ESSENZE.

## DIMENSIONS

CM 25 X 3,7 X 57 H

## COUNTERBOX DIMENSIONS

CM 37 X 10 X 54 H

## MATERIALS

CURVED SILK-SCREEN PRINTED GLASS  
PANEL;  
PAINTED ALUMINIUM RAL 9003.

## ECC - EFFEGIBI COMFORT CONTROL

THIS SYSTEM IS INCORPORATED INTO  
EVERY EFFEGIBI STEAM GENERATOR  
SO THAT THE TURKISH BATH CAN  
BE REMOTEY CONTROLLED, JUST  
DOWNLOAD THE APP EFFEGIBI  
EXPERIENCE TO YOUR TABLET  
OR SMARTPHONE.

MODELLO MODEL AQUASTEAM	VOLUME VANO COMPARTMENT VOLUME (M <sup>3</sup> )	POTENZA POWER (KW)
30	0 - 3,5	3,0
45	3,5 - 4,5	4,5

# Easystem

## DIMENSIONI

CM 25 X 3,7 X 57 H

## DIMENSIONI CONTROCASSA

CM 37 X 10 X 54 H

## MATERIALI

VETRO CURVATO SERIGRAFATO;  
ALLUMINIO VERNICIATO RAL 9003.

## GENERATORE DI VAPORE INTERNO

CARATTERISTICHE:  
SISTEMA AUTOMATICO DI  
LAVAGGIO CALDAIA;  
SISTEMA DI REGOLAZIONE  
PORTATA ACQUA;  
SISTEMA AUTOMATICO DI  
SCARICO ACQUA;  
FUNZIONE ENERGY SAVER AUTOMATICA;  
PANNELLO DI CONTROLLO TOUCH  
CON ICONE RETROILLUMINATE E  
INDICATORE DEL LIVELLO DI  
TEMPERATURA.  
CONTENITORI PER ESSENZE.

## ECC - EFFEGIBI COMFORT CONTROL

IL SISTEMA È INTEGRATO NEL  
GENERATORE DI VAPORE CHE CONSENTE  
DI GESTIRE A DISTANZA IL BAGNO TURCO,  
SCARICANDO L'APPOSITA APP EFFEGIBI  
EXPERIENCE SUL PROPRIO TABLET O  
SMARTPHONE.

## DIMENSIONS

CM 25 X 3,7 X 57 H

## COUNTERBOX DIMENSIONS

CM 37 X 10 X 54 H

## MATERIALS

CURVED SILK-SCREEN PRINTED GLASS  
PANEL;  
PAINTED ALUMINIUM RAL 9003;

## EQUIPPED COLUMN WITH:

BUILT IN STEAM GENERATOR;  
AUTOMATIC BOILER CLEANING SYSTEM;  
WATER FLOW RATE CONTROL SYSTEM;  
AUTOMATIC WATER DRAINAGE SYSTEM;  
AUTOMATIC ENERGY SAVER FUNCTION;  
TOUCH-SCREEN CONTROL PANEL WITH  
BACKLIT ICONS AND TEMPERATURE GAUGE.  
CONTAINERS FOR ESSENTIAL OILS.

## ECC - EFFEGIBI COMFORT CONTROL

THIS SYSTEM IS INCORPORATED INTO  
EVERY EFFEGIBI STEAM GENERATOR  
SO THAT THE TURKISH BATH CAN  
BE REMOTEY CONTROLLED, JUST  
DOWNLOAD THE APP EFFEGIBI  
EXPERIENCE TO YOUR TABLET OR  
SMARTPHONE.

MODELLO MODEL EASYSTEM	VOLUME VANO COMPARTMENT VOLUME (M <sup>3</sup> )	POTENZA POWER (KW)
30	0 - 3,5	3,0
45	3,5 - 4,5	4,5

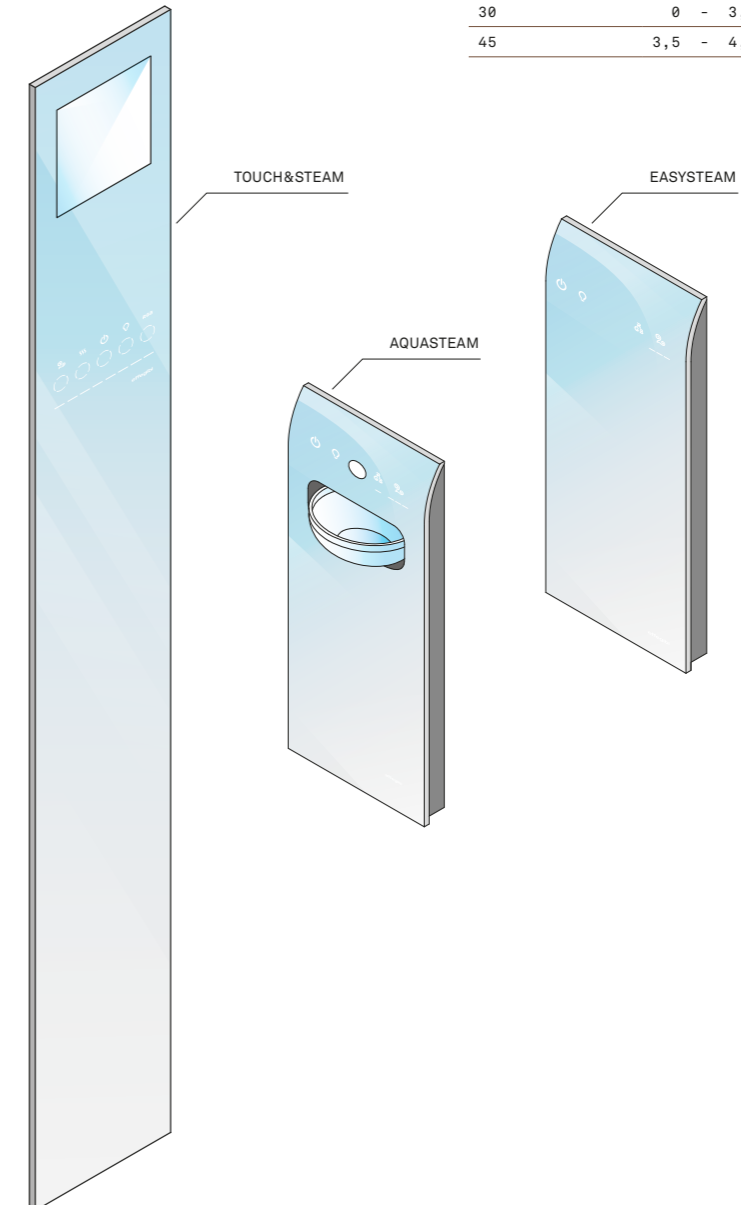

# Nuvola Smart Power

**DIMENSIONI GENERATORE**  
CM 52 X 26 X 27 H

**DIMENSIONI PANNELLO DI CONTROLLO**  
SCATOLA DA INCASSO : CM 19 X 8 X 4,3 H  
PANNELLO : CM 18 X 6 H

**DIMENSIONI DIFFUSORE DI VAPORE**  
CONTROCASSA : CM 18 X 10 X 15,2 H  
DIFFUSORE : CM 18,2 X 4,5 X 12,3 H

**GENERATORE DI VAPORE**  
CARATTERISTICHE:  
RWF REGULATING WATER FLOW;  
AUTOREGOLAZIONE ALLA PRESSIONE DELL'IMPIANTO IDRICO;  
SWF SMART WATER FILLING: GESTIONE OTTIMIZZATA DI RIEMPIMENTO CALDAIA;  
SBC SMART BOILER CLEANING: DILUIZIONI E RISCIAQUI INTERMEDI SUL REALE FABBISOGNO;  
RISCIAQUO FINALE;  
SEC SMART ENERGY CONTROL: DISTRIBUZIONE UNIFORME NEL TEMPO, DEI CICLI DI ACCENSIONE E SPEGNIMENTO DELLE TERMORESISTENZE;  
ODS OPEN DOOR SENSOR: SENSORE PORTA APERTA;  
ECC - EFFEGIBI COMFORT CONTROL: IL SISTEMA È INTEGRATO NEL GENERATORE DI VAPORE CHE CONSENTE DI GESTIRE A DISTANZA IL BAGNO TURCO, SCARICANDO L'APPOSITA APP EFFEGIBI EXPERIENCE SUL PROPRIO TABLET O SMARTPHONE.

**DIFFUSORE DI VAPORE**  
CARATTERISTICHE:  
ALETTE ORIENTABILI PER DIREZIONARE IL VAPORE;  
SISTEMA DI RICIRCOLO DELL'ARIA IN CABINA CON VENTILATORE WATER RESISTANT;  
CONTENITORE PER ESSENZE;  
LED LUMINOSO ALL'USCITA DEL VAPORE;  
SONDA DI TEMPERATURA AGGIUNTIVA.

**PANNELLO DI CONTROLLO TOUCH**  
CON ICONE RETROILLUMINATE E INDICATORE DEL LIVELLO DI TEMPERATURA.

**STEAM GENERATOR DIMENSIONS**  
CM 52 X 26 X 27 H

**CONTROL PANEL DIMENSIONS**  
MOUNTING BOX : CM 19 X 8 X 4.3 H  
CONTROL PANEL : CM 18 X 6 H

**STEAM DIFFUSER DIMENSIONS**  
MOUNTING BOX : CM 18 X 10 X 15.2 H  
STEAM DIFFUSER : CM 18.2 X 4.5 X 12.3 H

**STEAM GENERATOR**  
FEATURES:  
RWF REGULATING WATER FLOW;  
CAN WORK ON A WIDE RANGE OF WATER SYSTEMS WITH DIFFERENT PRESSURES;  
SWF SMART WATER FILLING: OPTIMISED MANAGEMENT OF BOILER FILLING;  
SBC SMART BOILER CLEANING: DILUTION AND INTERMEDIATE RINSING PROCESSES NOT TIME CONTROLLED BUT BASED ON REAL NEED;  
SEC SMART ENERGY CONTROL: EVENLY SPACED ON/OFF PERIODS FOR THE HEATING ELEMENTS;  
ODS OPEN DOOR SENSOR  
ECC - EFFEGIBI COMFORT CONTROL: THIS SYSTEM IS INCORPORATED INTO EVERY EFFEGIBI STEAM GENERATOR SO THAT THE TURKISH BATH CAN BE REMOTELY CONTROLLED, JUST DOWNLOAD THE APP EFFEGIBI EXPERIENCE TO YOUR TABLET OR SMARTPHONE.

**STEAM DIFFUSER**  
FEATURES:  
ADJUSTABLE FLAPS TO CONTROL THE OUTGOING STEAM DIRECTION;  
CUBICLE AIR-RECIRCULATION SYSTEM BUILT INTO THE WATER-RESISTANT FAN;  
ESSENTIAL OILS CONTAINER;  
STEAM OUTPUT LED LIGHT;  
ADDITIONAL TEMPERATURE PROBE INSIDE THE DIFFUSER.

**TOUCH-SCREEN CONTROL PANEL**  
WITH BACKLIT ICONS AND TEMPERATURE GAUGE.

MODELLO MODEL	VOLUME VANO COMPARTMENT VOLUME (M <sup>3</sup> )	POTENZA POWER (KW)
25	0 - 2,5	2,5
30	2,5 - 3,5	3,0
45	3,5 - 4,5	4,5
55	4,5 - 5,5	5,5
70	5,5 - 7,2	7,0
90	7,2 - 9,2	9,0
110	9,2 - 12,0	11,0
140	12,0 - 15,0	14,0
180	15,0 - 25,0	18,0
250	25,0 - 35,0	25,0
360	35,0 - 50,0	36,0

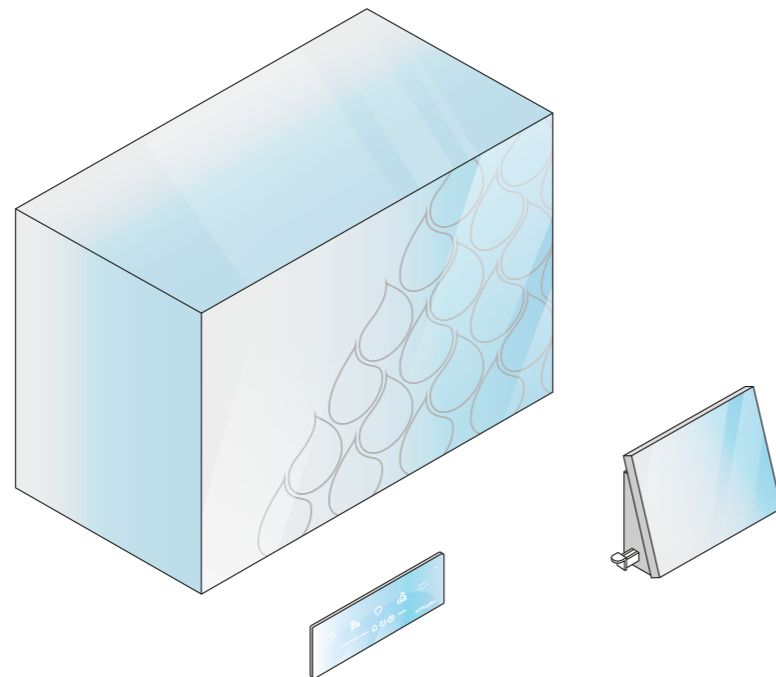

# Omniasteam Touch

**DIMENSIONI**  
88: CM 88 X 198 H  
145: CM 145 X 198 H

**DIMENSIONI CONTROTELAIO**  
88: CM 93 X 202 H  
145: CM 150 X 202 H

**MATERIALI**  
VETRO TEMPERATO TRASPARENTE 6 MM  
FINITURA ALLUMINIO: ALLUMINIO  
FINITURA BRILLANTE;  
FINITURA BIANCO: ALLUMINIO  
VERNICIATO RAL 9010 OPACO;

**GENERATORE DI VAPORE INTERNO**  
CARATTERISTICHE:  
SISTEMA AUTOMATICO DI LAVAGGIO CALDAIA;  
SISTEMA DI REGOLAZIONE PORTATA ACQUA;  
SISTEMA AUTOMATICO DI SCARICO ACQUA;  
FUNZIONE ENERGY SAVER AUTOMATICA;  
PANNELLO DI CONTROLLO TOUCH CON ICONE RETROILLUMINATE E INDICATORE DEL LIVELLO DI TEMPERATURA;  
FUNZIONE POWER STEAM: SISTEMA DI DIFFUSIONE VAPORE A VENTILAZIONE FORZATA;  
FUNZIONE CALDO DOCCIA: SISTEMA DI RISCALDAMENTO A VENTILAZIONE FORZATA CON FUNZIONE PRERISCALDAMENTO VANO.

SENSORE PORTA APERTA.  
CONTENITORI PER ESSENZE.

ILLUMINAZIONE CON CROMOTERAPIA A LED RGB 5 COLORI FISSI, 4 CICLI DINAMICI E LUCE BIANCA.

**ECC - EFFEGIBI COMFORT CONTROL**  
IL SISTEMA È INTEGRATO NEL GENERATORE DI VAPORE CHE CONSENTE DI GESTIRE A DISTANZA IL BAGNO TURCO, SCARICANDO L'APPOSITA APP EFFEGIBI EXPERIENCE SUL PROPRIO TABLET O SMARTPHONE.

MODELLO MODEL	VOLUME VANO COMPARTMENT VOLUME (M <sup>3</sup> )	POTENZA POWER (KW)
30	0 - 3,5	3,0
45	3,5 - 4,5	4,5

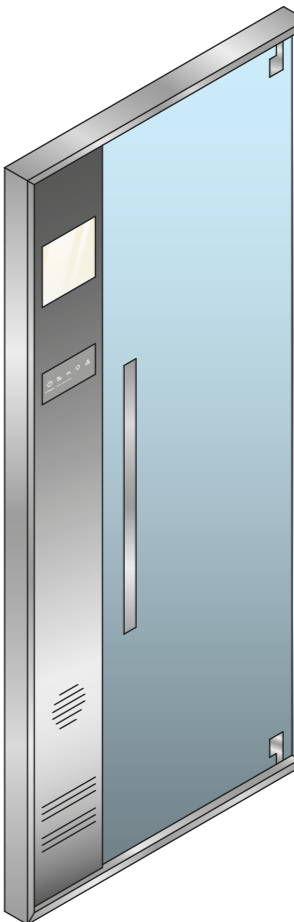

**DIMENSIONS**  
88: CM 88 X 198 H  
145: CM 145 X 198 H

**COUNTERFRAME DIMENSIONS**  
88: CM 93 X 202 H  
145: CM 150 X 202 H

**POWER**  
30: 3.0 KW MAX KW MAX  
45: 4.5 KW MAX KW MAX  
230 VAC 1N 50-60 HZ  
400 VAC 3N 50-60 HZ

**MATERIALI**  
6 MM CLEAR TEMPERED GLASS  
FINISHING ALUMINIUM: ALUMINIUM  
EDGES WITH SHINY FINISHING  
FINISHING WHITE: EDGES IN PAINTED RAL 9010 OPAQUE WHITE ALUMINIUM

**BUILT IN STEAM GENERATOR**  
FEATURES:  
AUTOMATIC BOILER CLEANING SYSTEM;  
WATER FLOW RATE CONTROL SYSTEM;  
AUTOMATIC WATER DRAINAGE SYSTEM;  
AUTOMATIC ENERGY SAVER FUNCTION;  
TOUCH-SCREEN CONTROL PANEL WITH BACKLIT ICONS AND TEMPERATURE GAUGE.  
POWER STEAM FUNCTION: STEAM DIFFUSION AND FORCED VENTILATION HEATING SYSTEM;  
CALDO DOCCIA FUNCTION: UNIT PRE-HEATING FUNCTION WITH FORCED VENTILATION HEATING SYSTEM.

OPEN DOOR SENSOR.  
CONTAINER FOR ESSENTIAL OILS.

LIGHTING SYSTEM WITH LED RGB COLOUR THERAPY, 5 FIXED COLOURS, 4 DYNAMIC CYCLES AND WHITE LIGHT.

**ECC - EFFEGIBI COMFORT CONTROL**  
THIS SYSTEM IS INCORPORATED INTO EVERY EFFEGIBI STEAM GENERATOR SO THAT THE TURKISH BATH CAN BE REMOTELY CONTROLLED, JUST DOWNLOAD THE APP EFFEGIBI EXPERIENCE TO YOUR TABLET OR SMARTPHONE.

# FeelGood

## DIMENSIONI SOFFIONE

CM 47 X 67

## DIMENSIONI PANNELLO DI CONTROLLO

SCATOLA DA INCASSO:  
CM 31 X 9,8 X 6,6 H

PANNELLO:  
CM 30 X 6H

## FINITURE

ACCIAIO SPAZZOLATO  
ACCIAIO INOSSIDABILE LUCIDO

## SOFFIONE MULTIFUNZIONE

SOFFIONE DA SOFFITTO CON FUNZIONI  
PIOGGIA, CASCATA, NEBULIZZAZIONE;  
LUCE BIANCA;  
CROMOTERAPIA (ROSSO, BLU, VERDE,  
GIALLO) E PROGRAMMA "FEEL";  
MISCELATORE TERMOSTATICO 3/4"  
INCASSO CON DEVIATORE 3 VIE;  
PANNELLO DI CONTROLLO TOUCH  
CON ICONE RETROILLUMINATE PER  
LA GESTIONE DI TUTTE LE FUNZIONI  
(DOCCIA, VAPORE, LUCE) COMPLETO  
DOCCIA CON ON/OFF AUTOMATICO.

## SHOWER HEAD DIMENSIONS

CM 47 X 67

## CONTROL PANEL DIMENSIONS

MOUNTING BOX:  
CM 31 X 9,8 X 6,6 H

CONTROL PANEL:  
CM 30 X 6H

## FINISHES

BRUSHED STAINLESS STEEL  
BRILLIANT STAINLESS STEEL

## EQUIPPED SHOWER HEAD

CEILING SHOWER HEAD, RAINFALL,  
WATERFALL AND MIST FUNCTION;  
WHITE LED LIGHTS;  
CHROMOTHERAPY (RED, BLUE, GREEN,  
YELLOW) AND "FEEL" PROGRAM;  
3/4" BUILT-IN THERMOSTATIC MIXER  
WITH 3-WAY DIVERTER;  
TOUCH-SCREEN CONTROL PANEL WITH  
BACKLIT ICONS OPERATES ALL  
THE FUNCTIONS (SHOWER, STEAM,  
LIGHTING);  
SHOWER SET WITH AUTOMATIC ON/OFF.

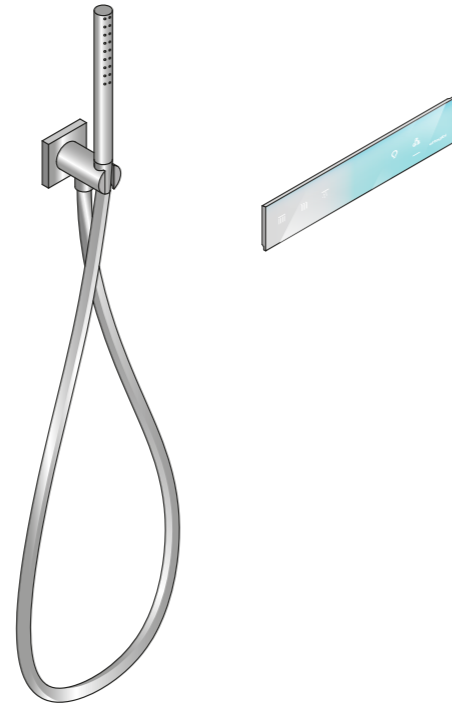
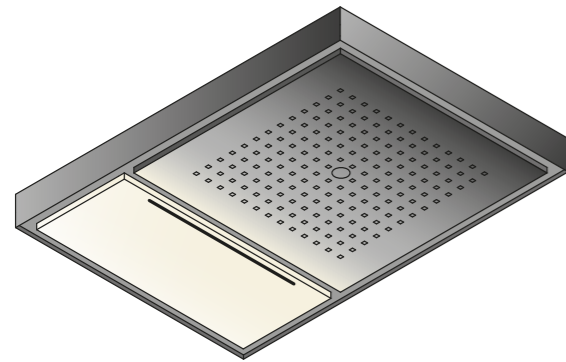

<div> </div>	<div> </div>
<div> </div>	<div> </div>

<b><span>→</span> 4</b>
<div> </div>

**Depuis plus de vingt-cinq ans, Effegibi conçoit et produit des saunas et des bains turcs avec des technologies d'avant-garde.**

Effegibi est au centre d'une histoire qui a ses origines dans la tradition et qui arrive dans un avenir plus innovant. L'histoire est celle du bien-être, de rites anciens comme le sauna et le bain turc qui, aujourd'hui, revêt un style contemporain grâce à des technologies avancées et un design raffiné. Derrière cette évolution, il y a une entreprise qui, depuis 1987, a consacré son activité uniquement à ce secteur, fière d'offrir une production de bains turcs et de saunas entièrement italienne, de la conception à la production. Avec cette philosophie, Effegibi est devenue à juste titre leader dans son secteur, en gagnant la confiance de ses clients dans le monde entier. Un atout est donné de l'excellence des solutions technologiques, toujours à l'avant-garde qui garantissent des produits de qualité certifiée, de longue durée, avec un entretien extrêmement réduit et assurant une économie d'énergie. En plus de rechercher des fonctionnalités et des performances élevées, Effegibi sait parfaitement que bien-être rime avec « bel être » et accorde de fait la même attention à l'esthétique.

Les saunas et les bains turcs sont dessinés avec des lignes nettes, tracées par des designers illustres, souvent avec de grandes ouvertures vitrées qu'ils les transforment en des objets d'ameublement élégants. Les matériaux sont éocompatibles, aucune matière plastique n'est utilisée, les types de bois sont de premier choix et ne proviennent pas de la déforestation ni d'arbres en voie de disparition. Le savoir-faire extraordinaire d'Effegibi se traduit en des solutions précises sur mesure.

<div> </div>	<div> </div>
<div> </div>	<div> </div>

<div> </div>	<div> </div>
<div> </div>	<div> </div>

<div> </div>	<div> </div>
<div> </div>	<div> </div>

<div> </div>	<div> </div>
<div> </div>	<div> </div>

<div> </div>	<div> </div>
<div> </div>	<div> </div>

Le sauna et le bain turc ont des bénéfices similaires mais des origines et des modes d'emploi différents

**Sauna finlandais**

Un rite qui s'est répandu depuis le nord de l'Europe dans le monde entier. Dans le sauna, la chaleur peut atteindre des températures jusqu'à 100 °C, mais grâce à la basse humidité (20-30 %), elle se transforme en un agréable enlacement qui détend la musculature et favorise l'épuration de l'organisme. Le bois libère le parfum de la nature, une invitation primitive à retrouver la sérénité de l'esprit en relâchant toutes les tensions. Construisez d'abord votre sauna, puis votre maison. Ce vieux

## Perfect WellneS

<div> </div>	<div> </div>
<div> </div>	<div> </div>

dicton finlandais raconte comme un simple bain d'air chaud et sec puisse devenir le centre vital du bien-être quotidien.

**Bain turc**

L'eau est synonyme de santé, même lorsqu'elle prend la forme d'un nuage de vapeur qui enveloppe le corps. Le bain turc fut découvert jadis par les grecs, les romains et les peuples du Moyen-Orient qui en ont fait une philosophie de vie. Contrairement au sauna, l'humidité atteint 100 % et les températures ne dépassent pas 48 °C. Assis sur le marbre ou sur la pierre, enveloppés par un brouillard impalpable, on inhale la vapeur tiède qui décongestionne la respiration, on se libère de toutes les toxines à travers la transpiration, on s'isole de l'espace environnant et on perçoit uniquement notre corps.

<div> </div>	<div> </div>
<div> </div>	<div> </div>

<div> </div>	<div> </div>
<div> </div>	<div> </div>

Système modulaire qui unit sauna, bain turc, douche : un véritable spa personnel, conçu pour être versatile et élégant.

Dans la version sauna + hammam, BodyLove permet diverses possibilités d'orientation et positionnement des portes d'accès aux deux espaces.

Le poêle du sauna de BodyLove est revêtu en céramique émaillée, avec des couleurs uniques : un matériau précieux qui exalte la douce beauté du bois. La source de chaleur, élément extrêmement important dans la tradition du sauna finlandais, occupe à nouveau également dans l'esthétique un rôle de premier plan.

L'offre de matériaux précieux comme la céramique et le grès stimule la perception de l'espace bien-être comme un environnement en continuité avec l'extérieur, plutôt que comme un élément technique ajouté et non intégré. BodyLove prévoit la possibilité d'une personnalisation complète également dans le choix des matériaux.

Fonctionnel, élégant, prestigieux : Rodolfo Dordoni signe un projet qui attise les sens. Personnalisez selon vos goûts votre spa, privée ou publique, grâce à BodyLove, un système modulaire qui permet l'union de sauna, bain turc, douche, zone de détente, selon des dispositions toujours nouvelles et avec des matériaux même personnalisables.

Un plan en marbre Botticino contient le groupe des robinets (distributeur et commandes fontaine + douche), ainsi qu'un bol en acier effet cuivre pour se mouiller avec de l'eau fraîche durant le bain de vapeur.

<div> </div>	<div> </div>
<div> </div>	<div> </div>

<div> </div>	<div> </div>
<div> </div>	<div> </div>

Les parois sont proposées en deux diverses essences de bois : Hemlock naturel et bois massif thermo-traité, avec la possibilité d'insérer sur demande des surfaces en miroir.

Comme tous les produits Effegibi, BodyLove offre un éventail de possibilités de personnalisation en termes de choix et assortiment des matériaux pour réaliser un espace bien-être vraiment sur mesure.

<div> </div>	<div> </div>
<div> </div>	<div> </div>

Sauna et bain turc en une solution unique, reliés par un espace douche élégant.

Logica contient toutes les fonctions d'un centre de bien-être complet, en maintenant un parfait équilibre entre fonctionnalité, esthétique et technologie.

Caractéristiques :
- Système intégré avec sauna, bain turc et douche

- Technologie Aquasteam pour la production de vapeur, pour un contrôle total de la qualité
- Douche dotée de pomme de douche anticalcaire et mitigeur à cartouche progressive et inverseur
- Matériaux de qualit exceptionnelle : bois Hemlock canadien, revêtements en grès laminé Slimtech® de 3,5 mm, portes en verre trempé de 8 mm
- ESS - Effegibi Sound System pour le contrôle de la musique directement depuis votre dispositif (en option)
- Disponible en sept finitions standard, ou avec des couleurs personnalisées
- Produit complet, disponible également pour des applications sur mesure

Matériaux :
Logica est fabriqué avec des technologies de dernière génération et des matériaux extrêmement précieux : bois de Hemlock canadien de premier choix et grès laminé Slimtech®, accouplé dans les caillebotis à verre trempé de 15 mm

Commandes tactiles :
Une colonne centrale comprend les commandes tactiles rétro-illuminées du sauna, hammam et chromothérapie. Logica utilise une technologie extrêmement avancée pour le contrôle des fonctions, développée par les techniciens Effegibi pour une utilisation simple et intuitive. Rien ne dérangera votre relax.

<div> </div>	<div> </div>
<div> </div>	<div> </div>

LOGICA SH → **54**

<div> </div>	<div> </div>
<div> </div>	<div> </div>

Toute l'élégance du système Logica en un espace plus restreint. Sauna et bain turc deviennent un véritable projet de

<div> </div>	<div> </div>
<div> </div>	<div> </div>

design intégré dans votre maison.

Caractéristiques :
- Système intégré avec sauna et bain turc.
- Aquasteam est installé pour la production de vapeur, avec fonction Energy Saver et système automatique de lavage de la chaudière.
- Disponible en sept finitions standard, ou avec des couleurs personnalisées.

- Matériaux de qualité exceptionnelle : bois Hemlock canadien, revêtements en grès laminé Slimtech® de 3,5 mm, portes en verre trempé de 8 mm.
- ESS - Effegibi Sound System pour le contrôle de la musique directement depuis votre dispositif (en option)
- Logica SH est un espace de bien-être chez vous, versatile grâce aux trois variantes chromatiques

Quand la teneur en vapeur d'une pièce est supérieure à celle en eau de l'épiderme, une couche d'humidité se forme sur la peau et réchauffe ainsi le corps. L'action simultanée de la vapeur et de la chaleur contrôlée améliore la circulation sanguine lymphatique, de même qu'elle fait fondre les toxines et en favorise l'expulsion.

<div> </div>	<div> </div>
<div> </div>	<div> </div>

<div> </div>	<div> </div>
<div> </div>	<div> </div>

<div> </div>	<div> </div>
<div> </div>	<div> </div>

En 3 mètres seulement, Mid unit le sauna et le hammam en un seul objet de design précieux. La transparence entre les espaces rend l'impact esthétique léger et agréable.

Caractéristiques :
- Système intégré de sauna et douche avec bain turc

- Aquasteam pour la production de vapeur : le meilleur de la technologie pour le bain turc
- ESS - Effegibi Sound System pour le contrôle de la musique directement depuis votre dispositif (en option)
- Matériaux de qualité exceptionnelle : bois Hemlock canadien, revêtements en grès laminé Slimtech® de 3,5 mm, portes en verre trempé de 8 mm.
- Disponible en sept finitions standard, ou avec des couleurs personnalisées

- Produit complet, disponible également pour des applications sur mesure
- Espace douche pratique et fonctionnel, avec mitigeur thermostatique, douche à main et pomme de douche au plafond 42x42 cm avec fonctions pluie et nébulisation

<div> </div>	<div> </div>
<div> </div>	<div> </div>

<div> </div>	<div> </div>
<div> </div>	<div> </div>

Le rite du sauna se complète avec la zone douche, spécialement conçue dans le plein respect de la tradition finlandaise.

## 326

## FRANÇAIS

<div> </div>	<div> </div>
<div> </div>	<div> </div>

Caractéristiques :
- Système intégré avec sauna finlandais et douche
- Toute la zone sauna est revêtue en bois de Hemlock canadien, le matériau le plus précieux utilisé pour les saunas finlandais
- ESS - Effegibi Sound System pour le contrôle de la musique directement depuis votre dispositif (en option)
- La structure externe au sauna est disponible en trois finitions standard, ou avec des couleurs personnalisées
- De nombreuses applications possibles, dans des centres de bien-être, salles de gym ou à la maison

<div> </div>	<div> </div>
<div> </div>	<div> </div>

<div> </div>	<div> </div>
<div> </div>	<div> </div>

Logica H conjugue la magie du bain turc à l'espace douche en un produit unique qui devient un véritable coin de bien-être quotidien.

Caractéristiques :
- Système intégré avec bain turc et douche

- Aquasteam, la meilleure technologie disponible pour la production de vapeur
- Matériaux de qualité exceptionnelle : revêtements en grès laminé Slimtech® de 3,5 mm, portes en verre trempé de 8 mm.
- ESS - Effegibi Sound System pour le contrôle de la musique directement depuis votre dispositif (en option)
- Disponible en sept finitions standard, ou avec des couleurs personnalisées
- Tableau de commande Effegibi à voyants lumineux pour une visibilité parfaite des symboles également durant le bain de vapeur

Aquasteam est un distributeur de vapeur au design compact et élégant. Un panneau vitré incurvé équipé de commandes tactiles, intuitives et facilement visibles grâce aux voyants rétro-illuminés. Aquasteam est doté d'une fontaine pour la distribution de l'eau dans le bol, qui rappelle la tradition des anciens hammams.

<div> </div>	<div> </div>
<div> </div>	<div> </div>

<div> </div>	<div> </div>
<div> </div>	<div> </div>

<div> </div>	<div> </div>
<div> </div>	<div> </div>

<div> </div>	<div> </div>
<div> </div>	<div> </div>

Deux produits coordonnés au même design élégant et rationnel : One S, conçu pour une fonctionnalité maximale, et One H, qui unit savamment esthétique et technologie. Les deux cabines peuvent être facilement assemblées pour créer des espaces Spa privés ou publics, car elles permettent une grande flexibilité conceptuelle.

<div> </div>	<div> </div>
<div> </div>	<div> </div>

Caractéristiques :
- Une cabine sauna et une

## Perfect WellneS

<div> </div>	<div> </div>
<div> </div>	<div> </div>

cabine hammam coordonnées, assemblables en un même espace ou utilisables séparément
- One H utilise Aquasteam 45 pour la production de vapeur, pour un contrôle total de la densité et de l'hygiène
- Matériaux de qualité exceptionnelle : sauna en bois Hemlock, hammam avec revêtements en grès laminé Slimtech® de 3,5 mm
- ESS - Effegibi Sound System pour le contrôle de la musique directement depuis votre dispositif (en option)
- Disponible en sept finitions standard, ou avec des couleurs personnalisées
- De nombreuses applications possibles, dans des centres de bien-être, salles de gym ou à la maison

Le bain turc parfait s'obtient quand la densité de la vapeur est optimale et constante dans le temps, avec une température supérieure à 40 °C. Les hammams Effegibi ont une température et quantité de vapeur déclarée pour tous les générateurs : cela garantit une expérience de détente totale et une plus grande durée dans le temps.

L'intérieur du One H est revêtu en grès laminé Slimtech® spécialement traité qui confère dans le contact avec le corps nu une agréable sensation naturelle et chaude.

<div> </div>	<div> </div>
<div> </div>	<div> </div>

<div> </div>	<div> </div>
<div> </div>	<div> </div>

Un sauna avec une esthétique extrêmement versatile, caractérisé par de grandes cloisons vitrées qui arrivent jusqu'au plafond : un objet lumineux et léger, parfait pour chaque pièce.

Caractéristiques :
- Sauna certifié, réalisé en bois précieux Hemlock canadien et vitres trempées de 10 mm

- Paroi frontale, porte et plafond en verre confèrent à Sky une extrême transparence et légèreté
- Disponible en trois modèles différents : Glass (verre seulement), Techno et Deco
- ESS - Effegibi Sound System, pour le contrôle de la musique directement depuis votre dispositif (en option)
- Grande versatilité, idéal pour des réalisations sur mesure

<div> </div>	<div> </div>
<div> </div>	<div> </div>

<div> </div>	<div> </div>
<div> </div>	<div> </div>

Nouveau modèle de la ligne Sky, avec une surface vitrée encore plus ample : un véritable coin transparent de lumière et de bien-être.

<div> </div>	<div> </div>
<div> </div>	<div> </div>

<div> </div>	<div> </div>
<div> </div>	<div> </div>

précieux Hemlock canadien et vitres trempées de 10 mm
- Surface vitrée extrêmement ample : paroi frontale, porte, plafond et paroi latérale
- ESS - Effegibi Sound System, pour le contrôle de la musique directement depuis votre dispositif (en option)
- Grande versatilité, idéal pour des réalisations sur mesure

<div> </div>	<div> </div>
<div> </div>	<div> </div>

<div> </div>	<div> </div>
<div> </div>	<div> </div>

<div> </div>	<div> </div>
<div> </div>	<div> </div>

Air est un sauna au design original et contemporain, caractérisé par la suspension des banquettes et par la symétrie des lignes, avec le poêle positionné au centre : la légèreté devient le caractère dominant.

Caractéristiques :
- Nouvelle ligne de saunas signée Talocci Design

- Les banquettes suspendues rendent le design plus léger et permettent l'installation sur le sol existant
- Le poêle positionné au centre fait d'Air un lieu de rencontre, où se détendre en compagnie
- Les mobiliers sont réalisées en bois précieux Aspen au naturel ou thermo-traité, très résistant dans le temps.
- ESS - Effegibi Sound System, pour le contrôle de la musique directement depuis votre dispositif (en option)

- Les plans des banquettes deviennent à l'extérieur un porte-serviettes et un plan d'appui fonctionnel
- De grandes surfaces vitrées sur toute la hauteur en cristal trempé de 10 mm
- L'éclairage à led positionné sous les banquettes exalte la légèreté de l'espace

<div> </div>	<div> </div>
<div> </div>	<div> </div>

<div> </div>	<div> </div>
<div> </div>	<div> </div>

Saunas résistants et pratiques, dont le design élégant s'intègre facilement à tout type d'environnement : c'est la ligne Effegibi dédiée aux hôtels, spas, centres sportifs et salles de gym.

Caractéristiques :
- Sauna certifié IMQ, réalisé en bois précieux Hemlock canadien, très résistant dans le temps

- Les banquettes et les protections sont faciles à enlever afin de permettre un nettoyage quotidien rapide et pratique
- La large porte, soutenue par des charnières solides, permet le passage de plusieurs personnes
- Placés sur une base périmétrale en aluminium afin d'éviter le contact entre bois et sol
- ESS - Effegibi Sound System,

<div> </div>	<div> </div>
<div> </div>	<div> </div>

pour le contrôle de la musique directement depuis votre dispositif (en option)

- Grande versatilité, idéal pour des réalisations sur mesure, même de grandes dimensions

<div> </div>	<div> </div>
<div> </div>	<div> </div>

<div> </div>	<div> </div>
<div> </div>	<div> </div>

Fabriqué entièrement en bois précieux de Pin finlandais ou Hemlock canadien sans nœuds, Auki combine l'ancienne tradition des saunas nord-européens avec un design moderne.

Caractéristiques :
- Sauna certifié IMQ, réalisé en bois précieux et cloisons vitrées en cristal trempé à basse émission de 8 mm
- Parois internes et externes caractérisées par des lattes de larges variables

- ESS - Effegibi Sound System, pour le contrôle de la musique directement depuis votre dispositif (en option)
- Auki s'adapte facilement aux exigences de l'espace à disposition, également pour des applications sur mesure

<div> </div>	<div> </div>
<div> </div>	<div> </div>

<div> </div>	<div> </div>
<div> </div>	<div> </div>

<div> </div>	<div> </div>
<div> </div>	<div> </div>

<div> </div>	<div> </div>
<div> </div>	<div> </div>

**Matériaux naturels**
Les saunas subissent d'énormes sollicitations thermiques, avec une température interne qui peut arriver jusqu'à 100 °C. Raison pour laquelle, les matériaux qui la composent sont un facteur fondamental pour la qualité. Aucun composant plastique n'est utilisé dans les saunas Effegibi, puisqu'il pourrait libérer, à des températures élevées, des substances nocives. Au contraire, les bois naturels garantissent un environnement sain, agréable au toucher, qui reste inaltéré pendant longtemps.

<div> </div>	<div> </div>
<div> </div>	<div> </div>

**Le choix du bois**
Le bois, pour être utilisé dans le sauna, doit avoir des caractéristiques précises d'absorption de la chaleur et de résistance au stress causé par les changements de température. Effegibi effectue en interne tous les essais nécessaires visant à assurer que les matériaux sont adéquats pour durer dans le temps et respectent les caractéristiques esthétiques nécessaires à fabriquer des saunas parfaits. De l'Hemlock canadien au Sapin de Suède traditionnel, plus de dix types de bois exclusivement de première choix sont sélectionnés par Effegibi et soumis à des contrôles rigoureux de qualité pour offrir un standard de qualité de très haut niveau.

## 327











## BIOSAUNA

→ **170**

→ **170**

La Biosauna es una sauna con niveles de temperatura entre los 50 y los 60º C y una humedad de aproximadamente 60-70%. Gracias al vaporizador integrado, configurando la temperatura preferida, la estufa Bio creará el equilibrio perfecto entre calor y humedad. El sistema combinado Effegibi permite elegir entre Biosauna, un recorrido a medio camino entre la sauna finlandesa y la naturaleza mediterránea del baño de vapor, o sauna tradicional, caracterizada por temperaturas de hasta 100 °C con baja humedad. El sistema combinado se puede aplicar a todas las saunas Effegibi.

→ **205**

→ **205**

→ **205**

El Touch&Steam, un generador de vapor profesional de diseño elegante y ligero, se puede acoplar a todas las duchas o ambientes hammam.

→ **219**

Características:
- Baño turco equipado con ducha, fuente, bancos y cromoterapia
- Materiales de nivel muy elevado: mármol en tres variantes, acero, vidrio templado, madera Teca natural de Birmania
- Vidrios internos de fondo disponibles en doble acabado: espejo y blanco
- Vidrios externos disponibles tanto completamente transparentes como en acabado efecto lluvia semimate
- Topkapi dispone de una fuente revestida en mármol de primera calidad, equipado con cuenco en acero con acabado de cobre
- Topkapi incluye ESS - Effegibi Sound System, para el control de la música directamente desde el propio dispositivo
- Panel touch intuitivo y retroiluminado para gestionar vapor, temperaturas, luz y cromoterapia
- Generador de vapor integrado en la columna que responde a un estándar de calidad único

El mármol es el protagonista en Topkapi como lo es en los hammam históricos más ricos de Turquía. Este extraordinario material, sumamente longevo y resistente, tiene un rendimiento táctil especial que amplifica el placer del baño turco.

→ **185**

→ **185**

→ **185**

→ **185**

→ **185**

→ **185**

→ **185**

## Perfect WellneS

## BIOSAUNA

→ **170**

→ **170**

Características:
- Hammam equipado con ducha y cromoterapia
- Tecnología Aquasteam para la generación del vapor: el máximo del control sobre la calidad de tu vapor
- Interno y mobiliario en Gres laminado 3,5 mm, puertas en vidrio templado de 8 mm
- Disponible en siete variantes cromáticas
- Espacio ducha cómodo y funcional, con mezclador termostático, ducha manual y alcachofa para ducha de techo de 42x42 cm con funciones lluvia y nebulización

→ **205**

→ **205**

→ **205**

→ **205**

El Touch&Steam, un generador de vapor profesional de diseño elegante y ligero, se puede acoplar a todas las duchas o ambientes hammam.

→ **219**

Características:
- Generador de vapor equipado con cromoterapia y aromaterapia
- Tecnología Effegibi para la generación del vapor: el máximo control sobre calidad, densidad e higiene
- Sistema de ventilación del aire que reduce al mínimo la estratificación de las temperaturas en el interior de la cabina
- Mantenimiento reducido gracias al sistema automático de lavado de la caldera que reduce al mínimo la acumulación de cal
- Diseño elegante y compacto formado por una placa de vidrio templado serigrafiado, con un grosor visible de 3,7 cm
- Panel de control touch con iconos retroiluminados e indicador del nivel de temperatura
- ESS - Effegibi Sound System, para el control de la música directamente desde el propio dispositivo (opcional)
- Calentamiento ducha: sistema de calentamiento de ventilación forzada con función de precalentamiento del compartimiento
- Se puede combinar con las puertas y paredes de vidrio de la gama Effegibi, diseñadas de forma específica para hammam

Puertas y paredes de vidrio: Touch&Steam se puede aplicar en cualquier ambiente predispueto para albergar un hammam: desde la ducha de casa a espacios más amplios, incluso diseñados a medida. Es fundamental que a estas áreas se apliquen puertas y paredes de vidrio específicas para hammam, capaces de aislar desde el exterior manteniendo un paso calibrado de aire.

Con Touch&Steam se aprecian los beneficios de la cromoterapia. Se

## BIOSAUNA

→ **170**

→ **170**

→ **170**

→ **170**

→ **170**

→ **170**

→ **170**

→ **170**

→ **170**

→ **170**

→ **170**

→ **170**

→ **170**

→ **170**

→ **170**

→ **170**

→ **170**

→ **170**

→ **170**

→ **170**

## ESPAÑOL

## BIOSAUNA

→ **170**

→ **170**

→ **170**

→ **170**

→ **170**

→ **170**

→ **170**

→ **170**

→ **170**

→ **170**

→ **170**

→ **170**

→ **170**

→ **170**

→ **170**

→ **170**

→ **170**

→ **170**

→ **170**

→ **170**

→ **170**

→ **170**

→ **170**

→ **170**

→ **170**

→ **170**

→ **170**

→ **170**

→ **170**

## ESPAÑOL

## BIOSAUNA

→ **170**

→ **170**

→ **170**

→ **170**

→ **170**

→ **170**

→ **170**

→ **170**

→ **170**

→ **170**

→ **170**

→ **170**

→ **170**

→ **170**

→ **170**

→ **170**

→ **170**

→ **170**

→ **170**

→ **170**

→ **170**

→ **170**

→ **170**

→ **170**

→ **170**

→ **170**

→ **170**

→ **170**

→ **170**

→ **170**

→ **170**

→ **170**

→ **170**

→ **170**

→ **170**

## ESPAÑOL

## BIOSAUNA

→ **170**

→ **170**

→ **170**

→ **170**

→ **170**

→ **170**

→ **170**

→ **170**

→ **170**

→ **170**

→ **170**

→ **170**

→ **170**

→ **170**

→ **170**

→ **170**

→ **170**

→ **170**

→ **170**

→ **170**

→ **170**

→ **170**

→ **170**

→ **170**

→ **170**

→ **170**

→ **170**

→ **170**

→ **170**

→ **170**

→ **170**

→ **170**

→ **170**

→ **170**

→ **170**

## ESPAÑOL

## BIOSAUNA

→ **282**

→ **282**

→ **282**

→ **282**

→ **282**

→ **282**

→ **282**

→ **282**

→ **282**

→ **282**

→ **282**

→ **282**

→ **282**

→ **282**

→ **282**

→ **282**

→ **282**

→ **282**

→ **282**

→ **282**

→ **282**

→ **282**

→ **282**

→ **282**

→ **282**

→ **282**

→ **282**

→ **282**

→ **282**

→ **282**

→ **282**

→ **282**

→ **282**

→ **282**

→ **282**

→ **282**

<sup>[1]</sup>





→ 4

**Effegibi设计与生产具有尖端技术的桑拿浴和土耳其浴，已有超过25年的历史。**Effegibi是历史传统与未来创新的结合体。健康的理念、古老的桑拿和土耳其浴传统具有悠久的历史，如今Effegibi将这一切与尖端的技术和优雅的设计完美结合。在这场演变的背后，有一家公司从1987年就开始专注于这个领域，并自豪的作为一家完全意大利本土的桑拿浴室和土耳其浴公司，专业提供相关产品的设计与生产。秉承这样的理念，Effegibi当之无愧地占据了此行业的领导地位，并获得世界各地客户的赞誉。Effegibi的尖端技术解决方案是最具特点的强项，不断寻求新技术来保证产品获得认证的超高品质、更长久寿命、极低维护频率以及超高效节能。不仅坚持寻求优异的产品品质与功能，Effegibi也同样重视产品的美观性与舒适度。桑拿房和土耳其浴室的设计具有简洁的线条，宽幅的玻璃面板的使用，将产品变成了室内陈列的优雅装饰物。使用的材料均为环保材料，杜绝使用塑料，所选木材均为优质等级，绝不滥砍滥伐或使用濒临灭绝的材料。Effegibi的卓越专长还体现在其严谨的定制解决方案上。

<b>BODYLOVE</b>	→ 21
<p>结合桑拿浴、土耳其浴、淋浴为一体的整体模块系统：一款设计优雅而多变的真正专属私人洗浴空间</p>	
<p>BodyLove系列的桑拿浴 + 土耳其浴组合，可以将门设置在不同方位，提供多种进入这两个空间的方式。</p>	
<p>BodyLove 系列桑拿炉外饰面选用色彩独特的上釉的瓷砖：这种优质材料更加凸显出木材的柔美。热源作为传统芬兰桑拿浴的核心组成部分，也在整个桑拿房部分的美观性上独放光彩。</p>	
<p>优质材料的选择，如瓷砖、格蕾丝等，可以使整个SPA空间与外部环境完美融合，而不像一个突兀的工业产品那样，被单独摆放在空间之</p>	
<p>芬兰桑拿浴从北欧流行到全世界的一种洗浴仪式。在桑拿浴中，温度最高可以达到100°C，但是因为相对较低的湿度</p>	

( 20-30% )，这种热量被转化为如同温暖的怀抱一般，能帮助有效的放松肌肉并净化机体。从桑拿房中我们可以感受到木材散发出的自然香气，让我们缓缓的放松大脑，释放压力。“先打造桑拿浴室，再建造自己的家”。这句芬兰的古话，道出了芬兰桑拿浴这项高温干燥的洗浴方式，可以成为我们日常生活的健康中心。

**土耳其浴**水关乎健康，即使变成云雾状，环绕在人体四周的时候。早在远古时代，古希腊人、古罗马人以及中东人就将土耳其浴视作一种生活哲学。和桑拿浴相反，土耳其浴的湿度可以达到100%，但温度不会超过48°C。坐在大理石或石头上，周身雾气缭绕，通过温和的蒸汽的作用，呼吸变得顺畅，各种毒素都顺着汗液排出体外，在所处的环境中静静感知身体的呼唤。

<b>BODYLOVE</b>	→ 21
<p>结合桑拿浴、土耳其浴、淋浴为一体的整体模块系统：一款设计优雅而多变的真正专属私人洗浴空间</p>	
<p>BodyLove系列的桑拿浴 + 土耳其浴组合，可以将门设置在不同方位，提供多种进入这两个空间的方式。</p>	
<p>BodyLove 系列桑拿炉外饰面选用色彩独特的上釉的瓷砖：这种优质材料更加凸显出木材的柔美。热源作为传统芬兰桑拿浴的核心组成部分，也在整个桑拿房部分的美观性上独放光彩。</p>	
<p>优质材料的选择，如瓷砖、格蕾丝等，可以使整个SPA空间与外部环境完美融合，而不像一个突兀的工业产品那样，被单独摆放在空间之</p>	
<p>芬兰桑拿浴从北欧流行到全世界的一种洗浴仪式。在桑拿浴中，温度最高可以达到100°C，但是因为相对较低的湿度</p>	

内。BodyLove 系列可提供完善的定制方案，具备多种材料可供选择搭配。

功能多样，设计优雅，富有声望：Rodolfo Dordoni 大设计师在产品上进行签名，使得这套组合更具影响力。SPA空间可以完全按照您的想法进行定制，无论是私人的还是公共的，因为有了BodyLove这个系列，一款结合桑拿浴、土耳其浴、淋浴、休息区域为一体的整体模块系统，可以根据新的情况进行调整变换，甚至进行产品材料的定制。

Botticino米黄大理石台面上配置淋浴装置（出水口和控制器 + 淋浴），铜制漆面效果的不锈钢水钵，可以使人们在进行蒸汽浴的同时，感受水的清新凉爽。

墙体结构可以使用两种不同的木材：天然铁杉木和经过热处理的白蜡树木，同时可以根据个人需求，在室内表面安装镜子。

<b>LOGICA</b>	→ 37
<p>i特点：- 桑拿浴及土耳其浴完美结合。- 配置Aquasteam系列蒸汽发生器，具备能源节约功能及锅炉自动清洗功能。- 优质材料：优选加拿大铁杉木，厚度为3.5mm的Slimtech®陶瓷层压板，以及经过淬火处理的厚度为8mm的钢化玻璃门板。</p>	
<p>特点：- 桑拿浴、土耳其浴以及淋浴三合一系统。- Aquasteam系列蒸汽发生器，全方位监控以提供高品质蒸汽。- 淋浴花洒采用防水垢堵塞技</p>	
<p>术，并配置渐进式阀芯的控水器和分水器。- 选用优质材料：使用加拿大铁杉木，厚度为3.5mm的Slimtech®超薄陶瓷层压板，以及经过淬火处理的8mm厚的钢化玻璃门板。</p>	
<p>- ESS-Effegibi 声控系统，可以直接从设备上控制播放的音乐（可选配置）。- 提供三种标准的外观效果，或进行个人定制颜色。- 产品功能完善，并且可以进行尺寸定制</p>	
<p>材料：Logica 系列使用最新技术及最优质材料：加拿大优质铁杉木和Slimtech®陶瓷层压板，与厚度为15mm的经过淬火处理的钢化玻璃压合制成。</p>	
<p>碰触式控制：位于中部的控制面板，通过背光式触控屏，集中对桑拿浴、土耳其浴以及彩色灯光疗法进行操作控制。Effegibi技术人员秉承外观简洁、操作简便的产品理念，为您提供完全放松的SPA环境。</p>	
<b>LOGICA SH</b>	→ 54

Logica 系列高度融合了优雅完美的设计。桑拿浴及土耳其浴的设计，与您的家完美结合。

生活的理想选择，彩色光疗系统将您带入多彩的世界。

<b>MID</b>	→ 69
<p>Mid系列成功在3米的空间内，将桑拿浴和土耳其浴进行了极具设计感的完美结合。空间的透明设计使得产品外观显得轻盈简洁而惹人喜爱。</p>	
<p>特点：- 桑拿浴、土耳其浴与淋浴功能完美融合。- Aquasteam系列蒸汽发生器：专供土耳其浴的最佳科技</p>	
<p>- Mid 系列包含 ESS-Effegibi 声控系统，可以直接从设备上控制播放的音乐（可选配置）。- 优质材料：优选加拿大铁杉木，厚度为3.5mm的Slimtech®陶瓷层压板，以及经过淬火处理的厚度为8mm的钢化玻璃门板。</p>	
<p>- 可提供三种标准外观效果，或进行个人定制颜色。-产品功能完整，可以按照需求进行尺寸定制</p>	
<p>- 淋浴空间舒适且功能强大，配置恒温控水器，手持花洒及42x42cm的头顶大花洒，具备“雨水”和“水雾”效果。</p>	
<b>LOGICA S</b>	→ 92

淋浴空间的桑拿浴，完全准确地遵照芬兰传统桑拿浴进行设计。

特点：- 桑拿浴、土耳其浴与淋浴功能完美融合。- Aquasteam系列蒸汽发生器：专供土耳其浴的最佳科技

- Mid 系列包含 ESS-Effegibi 声控系统，可以直接从设备上控制播放的音乐（可选配置）。- 优质材料：优选加拿大铁杉木，厚度为3.5mm的Slimtech®陶瓷层压板，以及经过淬火处理的厚度为8mm的钢化玻璃门板。

- 可提供三种标准外观效果，或进行个人定制颜色。-产品功能完整，可以按照需求进行尺寸定制

- 淋浴空间舒适且功能强大，配置恒温控水器，手持花洒及42x42cm的头顶大花洒，具备“雨水”和“水雾”效果。

Aquasteam系列蒸汽发生器的设计，具有紧凑而美观的特点。弧形玻璃面板上配置了碰触式按键和Led背透式灯光，操作简便，可视性强。Aquasteam系列还特别具备泉水输送功能，通过指尖的碰触，使冷水流入配置的树脂水钵内，这正与古老的土耳其浴传统相呼应。

生活的理想选择，彩色光疗系统将您带入多彩的世界。

<b>MID</b>	→ 69
<p>Mid系列成功在3米的空间内，将桑拿浴和土耳其浴进行了极具设计感的完美结合。空间的透明设计使得产品外观显得轻盈简洁而惹人喜爱。</p>	
<p>特点：- 桑拿浴、土耳其浴与淋浴功能完美融合。- Aquasteam系列蒸汽发生器：专供土耳其浴的最佳科技</p>	
<p>- Mid 系列包含 ESS-Effegibi 声控系统，可以直接从设备上控制播放的音乐（可选配置）。- 优质材料：优选加拿大铁杉木，厚度为3.5mm的Slimtech®陶瓷层压板，以及经过淬火处理的厚度为8mm的钢化玻璃门板。</p>	
<p>- 可提供三种标准外观效果，或进行个人定制颜色。-产品功能完整，可以按照需求进行尺寸定制</p>	
<p>- 淋浴空间舒适且功能强大，配置恒温控水器，手持花洒及42x42cm的头顶大花洒，具备“雨水”和“水雾”效果。</p>	
<b>LOGICA S</b>	→ 92

淋浴空间的桑拿浴，完全准确地遵照芬兰传统桑拿浴进行设计。

特点：- 桑拿浴、土耳其浴与淋浴功能完美融合。- Aquasteam系列蒸汽发生器：专供土耳其浴的最佳科技

- Mid 系列包含 ESS-Effegibi 声控系统，可以直接从设备上控制播放的音乐（可选配置）。- 优质材料：优选加拿大铁杉木，厚度为3.5mm的Slimtech®陶瓷层压板，以及经过淬火处理的厚度为8mm的钢化玻璃门板。

- 可提供三种标准外观效果，或进行个人定制颜色。-产品功能完整，可以按照需求进行尺寸定制

- 淋浴空间舒适且功能强大，配置恒温控水器，手持花洒及42x42cm的头顶大花洒，具备“雨水”和“水雾”效果。

Aquasteam系列蒸汽发生器的设计，具有紧凑而美观的特点。弧形玻璃面板上配置了碰触式按键和Led背透式灯光，操作简便，可视性强。Aquasteam系列还特别具备泉水输送功能，通过指尖的碰触，使冷水流入配置的树脂水钵内，这正与古老的土耳其浴传统相呼应。

特点：- 芬兰桑拿浴及淋浴合二为一- 整个桑拿空间均采用优质加拿大铁杉木，是用于芬兰桑拿浴最珍贵的木材。- ESS-Effegibi 声控系统，可以直接从设备上控制播放的音乐（可选配置）。- 桑拿浴可提供三种标准的外观效果，或进行个人定制。- 桑拿浴及淋浴相互融合：营造舒服而功能强大的空间。

<b>ONE S ONE H</b>	→ 101
<p>两款产片来源于同一个优雅而理性的设计：One S桑拿浴系列功能丰富，One H 湿蒸系列则展现出外观与技术的完美结合。两款SPA可以轻松而完美的结合在一起，打造理想的个人或公共SPA洗浴空间，可以根据项目情况进行灵活搭配。</p>	
<p>特点：- One S 桑拿浴和 One H 湿蒸土耳其浴，可以在同一个环境里搭配使用，也可以根据需求单独使用；- One H 湿蒸土耳其浴使用Aquasteam 45型蒸汽发生器，提供高浓度且质地清洁的优质蒸汽。- 使用超高品质材料：桑拿浴使用加拿大优质铁杉木，土耳其浴则使用厚度为3.5mm的Slimtech®超薄陶瓷层压板。</p>	
<p>ESS-Effegibi 声控系统，可以直接从设备上控制播放的音乐（可选配置）。- 三种标准表面效果可供选择，或进行个性颜色定制。- 适用于多种类型空间，比如SPA中心、健身房或者自己家中。</p>	
<p>想获得完美的土耳其浴体验，就需要保证时刻拥有均衡而持久的高浓度蒸汽，且温度超过40°C。Effegibi的所有蒸汽发生器设备，均声明了其生产的蒸汽的温度及数量：这确保了您能够最大限度的享受湿蒸所带来的完美放松体验。One H 湿蒸房内饰面采用Slimtech®超薄陶瓷层压板，经过用心加工，专为与身体直接接触而设计，使身体获得自然而温热的感受。</p>	
<b>LOGICA H</b>	→ 96

Logica 湿蒸系列神奇的将土耳其浴与淋浴空间合为一体，使之成为我们日常生活中的健康空间。

特点：- 土耳其浴与淋浴空间融合为一体- 使用高端技术Aquasteam系列蒸汽发生器- 优质材料：土耳其浴系列使用厚度为3.5mm的Slimtech®超薄陶瓷层压板，密封门则采用经过淬火处理的8mm厚钢化玻璃。

- ESS-Effegibi 声控系统，可以直接从设备上控制播放的音乐（可选配置）。- 三种标准表面效果可供选择，或进行个性颜色定制。- Effegibi品牌LED亮光控制板面，保证在充满蒸气的浴室

内，控制板上的标志符号依然清晰可见。

Aquasteam系列蒸汽发生器的设计，具有紧凑而美观的特点。弧形玻璃面板上配置了碰触式按键和Led背透式灯光，操作简便，可视性强。Aquasteam系列还特别具备泉水输送功能，通过指尖的碰触，使冷水流入配置的树脂水钵内，这正与古老的土耳其浴传统相呼应。

两款产片来源于同一个优雅而理性的设计：One S桑拿浴系列功能丰富，One H 湿蒸系列则展现出外观与技术的完美结合。两款SPA可以轻松而完美的结合在一起，打造理想的个人或公共SPA洗浴空间，可以根据项目情况进行灵活搭配。

特点：- One S 桑拿浴和 One H 湿蒸土耳其浴，可以在同一个环境里搭配使用，也可以根据需求单独使用；- One H 湿蒸土耳其浴使用Aquasteam 45型蒸汽发生器，提供高浓度且质地清洁的优质蒸汽。- 使用超高品质材料：桑拿浴使用加拿大优质铁杉木，土耳其浴则使用厚度为3.5mm的Slimtech®超薄陶瓷层压板。

- ESS-Effegibi 声控系统，可以直接从设备上控制播放的音乐（可选配置）。- 三种标准表面效果可供选择，或进行个性颜色定制。- 适用于多种类型空间，比如SPA中心、健身房或者自己家中。

想获得完美的土耳其浴体验，就需要保证时刻拥有均衡而持久的高浓度蒸汽，且温度超过40°C。Effegibi的所有蒸汽发生器设备，均声明了其生产的蒸汽的温度及数量：这确保了您能够最大限度的享受湿蒸所带来的完美放松体验。One H 湿蒸房内饰面采用Slimtech®超薄陶瓷层压板，经过用心加工，专为与身体直接接触而设计，使身体获得自然而温热的感受。

特点：- 通过认证的整体桑拿房，使用珍贵的加拿大铁杉木，以及厚度为10mm的经过淬火处理的低排放钢化玻璃。- 桑拿浴室正面、门、顶部均采用玻璃面板，赋予了SKY系列极度透明而轻盈的感受。

- ESS-Effegibi声音系统，可以在自己的设备上控制播放的音乐（可选配置）。- 适用性极广，为定制款桑拿浴室的最理想选择。

桑拿浴室的外观具有极为广泛的适用性，大范围的玻璃面板可以直达浴室顶端：为您创造一个明亮而轻盈的桑拿浴室，适合与任意环境完美搭配。

特点：- 通过认证的整体桑拿房，使用珍贵的加拿大铁杉木，以及厚度为10mm的经过淬火处理的低排放钢化玻璃。- 桑拿浴室正面、门、顶部均采用玻璃面板，赋予了SKY系列极度透明而轻盈的感受。- 提供三种设计可供选择：Glass风格（只含玻璃），Techno风格以及Deco风格。

- ESS-Effegibi声音系统，可以在自己的设备上控制播放的音乐（可选配置）。- 适用性极广，为定制款桑拿浴室的最理想选择。

<b>SKY CORNER</b>	→ 123
<p>SKY 系列的新款桑拿房，更大范围采用玻璃面板：营造了一个明亮、舒适的透明角落。</p>	
<p>特点：- 通过认证的整体桑拿房，使用珍贵的加拿大铁杉木，以及厚度为10mm的经过淬火处理的低排放钢化玻璃。- 桑拿浴室正面、门、顶部均采用玻璃面板，赋予了SKY系列极度透明而轻盈的感受。</p>	
<p>- ESS-Effegibi声音系统，可以在自己的设备上控制播放的音乐（可选配置）。- 适用性极广，为定制款桑拿浴室的最理想选择。</p>	

特点：- 通过认证的整体桑拿房，使用珍贵的加拿大铁杉木，以及厚度为10mm的经过淬火处理的低排放钢化玻璃。- 桑拿浴室正面、门、顶部均采用玻璃面板，赋予了SKY系列极度透明而轻盈的感受。

- ESS-Effegibi声音系统，可以在自己的设备上控制播放的音乐（可选配置）。- 适用性极广，为定制款桑拿浴室的最理想选择。

AIR → 133

Air系列桑拿浴为原创现代设计，悬空式座椅，对称式结构线条，居中式桑拿炉：简洁轻便

Air 系列桑拿浴为原创现代设计，悬空式座椅，对称式结构线条，居中式桑拿炉：简洁轻便
是这款桑拿房的主要特点。

特点
- 新款桑拿房印有设计师 Talocci的签名。

- 悬空长椅使得设计更显轻巧，并且桑拿房可以安装在已经铺好地板的地面上。
- 居中式桑拿炉使得Air系列桑拿房成为相聚的休闲场所，人们可以在相互陪伴下休息放松。

- 内部及墙板选用产自立陶宛的天然或热恒温处理的白杨木材，使得此款桑拿房长久耐用。

- ESS-Effegibi声音系统，可以在自己的设备上控制播放的音乐（可选配置）。
- 长凳的层次在桑拿房外成为搭放毛巾或可用的背靠。
- 桑拿房表面大范围采用经过高温淬火处理的钢化玻璃，厚度为10mm。
- 长椅下置的LED背光灯使得整个环境显得尤为轻松而愉悦。

GYM → 147

GYM系列桑拿房为原创现代设计，悬空式座椅，对称式结构线条，居中式桑拿炉：简洁轻便

GYM系列桑拿房为原创现代设计，悬空式座椅，对称式结构线条，居中式桑拿炉：简洁轻便

这款桑拿房坚实耐用、实用性强，优雅的产品设计适合搭配各种环境：这是Effegibi专为酒店、SPA中心、健身中心以及休闲会所量身打造的桑拿产品。

特点:
- 通过IMQ认证的整体桑拿房，使用优质加拿大铁杉木，持久耐用。
- 长凳及保护装置均采用易拆卸系统，用来方便进行日常清理。
- 配置宽幅的门板并采用更为坚固的铰链，方便多人同时通过。

- 桑拿房置于四周用铝条围起的地台上，以避免木材与地板直接接触。

- ESS-Effegibi声音系统，可以在自己的设备上控制播放的音乐（可选配置）。
- 多种选择，适用于各种环境甚至大空间定制。

AUKI → 155

完全采用芬兰珍贵的云杉木或加拿大无结铁杉木制成，Auki系列展现了北欧传统古老的桑拿浴与现代设计的完美结合。

特点:
- 通过IMQ认证的整体桑拿房，使用珍贵的木材及经过淬火处理的低排放钢化玻璃，厚度为8mm。
- 内部及外部墙体可由不同宽度的木条组成，极具特色。
- ESS-Effegibi声音系统，可以在自己的设备上控制播放的音乐（可选配置）。
- Auki 适用于已有空间的需求，也可根据实际情况提供尺寸定制。

NATURAL MATERIALS → 163

TOPKAPI → 175

BIOSAUNA → 170

Biosauna生态桑拿浴为原创现代设计，悬空式座椅，对称式结构线条，居中式桑拿炉：简洁轻便

**天然材料**
桑拿浴需要经受很高的温度，可以达到100°C的室内温度。因此，所选材料必须保证极高的质量。Effegibi的桑拿浴室从不使用塑料材料，因为随着温度的不断升高，从塑料中可能释放出有毒物质。相反，使用天然木材可以保证健康的环境，舒适的触感，经久耐用而不变形。

**木材的选择**
制作桑拿房所选用的木材，需要具备承受高温，且在温度高低变化下依然稳定不变形的特点。Effegibi内部严格执行所有必要测试，以保证

证选择的木材在长期使用中，依然能保持桑拿起初的外观特点及使用特性。从加拿大铁杉木到传统的瑞典云杉木，Effegibi精心挑选出十多种优质木材，所有材料均通过严格的质量把控，以保证卓越的产品质量标准。

BIOSAUNA → 170

生态桑拿浴系列
Biosauna 生态桑拿浴是桑拿浴的一种，通常温度可达到50°C到60°C，湿度可达到60 / -70%。通过内置蒸汽生成器，对喜欢的温度进行设置，Biosauna生态桑拿炉可以创造温度与湿度的完美平衡。

Effegibi 这种组合系统，可以为您提供Biosauna生态桑拿浴，一种介于芬兰桑拿浴和地中海蒸汽浴的折中方案，或者能够达到100°C高温、相对干燥的传统芬兰桑拿浴。这种组合系统可以应用于Effegibi的各款桑拿房。

TOPKAPI → 175

TAUCH&STEAM → 205

Tauch&amp;Steam系列桑拿房为原创现代设计，悬空式座椅，对称式结构线条，居中式桑拿炉：简洁轻便

Topkapi 系列是古老的土耳其浴的纯粹代表：外饰面选用卡拉拉大理石、黑白根大理石或米黄大理石，配置了相同质量标准下外形各异的蒸汽发生器。

特点:
- 土耳其浴完整配置了淋浴、泉水、长椅以及彩色光谱疗法
- 超高品质材料：3种不同的大理石材料可供选择，不锈钢框架，经过淬火处理的钢化玻璃，缅甸天然柚木座椅
- 内部玻璃可提供两种表面处理：镜面效果和白色效果
- 外部玻璃面可采用完全透明效果，或半哑光雨水效果。
- Topkapi 系列采用优等大理

石，配置抛光铜漆面处理的不锈钢水钵。

- Topkapi 系列配置Effegibi声音系统（EES），可在自己的设备上控制播放的音乐（可选配置）。
- 带背光灯的碰触式控制面板，用来调节蒸汽、温度、灯光及彩色光谱疗法。
- 蒸汽发生器嵌入在大理石柱体内，符合统一的质量标准。

大理石材料是整个Topkapi系列的主角，正如最古老而奢华的土耳其传统浴室也采用大理石材一样。这种非凡的材料，具有极长的使用寿命和高度的耐磨性，材质本身良好的触感更增添了进行土耳其浴时的享受。

H → 185

TRANSFORM YOUR SHOWER INTO A HAMMAM → 216

EASYSYSTEM → 227

TAUCH&STEAM → 205

TAUCH&STEAM → 205

TAUCH&STEAM → 205

TAUCH&STEAM → 205

特点:
- 土耳其浴配置了淋浴和彩色光谱疗法。
- 采用Aquasteam技术蒸汽发生器：提供全方位监控的高品质蒸汽。
- 内部装饰采用3.5mm的Slimtech®超薄陶瓷层压板，门板采用经过淬火处理的8mm厚钢化玻璃。
- 提供三种不同颜色的边框漆面。
- 淋浴空间舒适而功能性强，配置恒温控水器、手持花洒以及42x42cm头顶花洒，提供雨式出水和雨雾出水模式。

TOUCH&STEAM → 205

TAUCH&STEAM → 205

TAUCH&STEAM → 205

可安装在任何淋浴间或蒸汽室的Touch&steam蒸汽发生器，是一款设计优雅而轻盈

的专业蒸汽设备，是当今生产蒸汽的最先进技术。

Aquasteam系列蒸汽发生器为原创现代设计，悬空式座椅，对称式结构线条，居中式桑拿炉：简洁轻便

特点
- 蒸汽发生器配置彩色光谱疗法及香氛疗法。

- Effegibi技术研发的蒸汽发生器：严格控制蒸汽的质量、浓度及清洁度。
- 空气推送系统可以保证蒸汽房内的温度平均分布。
- 锅炉自动清洗功能可以降低维护频率，以及减少石灰石的生成与堆积。
- 设计优雅而紧凑，仅由一块丝网钢化玻璃面板制成，可见厚度仅为3.7cm。
- 触摸式控制面板，配置背光式图标以及温度指示器。
- ESS-Effegibi声音系统，可以在自己的设备上控制播放的音乐（可选配置）。
- 暖浴功能：配置预加热系统，通过热风推送来预先加热空间的温度。
- 可以和Effegibi品牌的任意门板及玻璃面板进行搭配，尤其适用于专业土耳其浴室设计。

门板和玻璃:
Touch&Steam 系列可安装在任何土耳其浴内：从家庭的淋浴间到更大的健康空间，以及特殊定制类的空间。给蒸汽浴室配置专用的蒸汽密封门板和玻璃，是使蒸汽完全锁定在浴室内并与外界新鲜空气进行交换的根本保障。

EASYSYSTEM → 227

TAUCH&STEAM → 205

TAUCH&STEAM → 205

TAUCH&STEAM → 205

TAUCH&STEAM → 205

TAUCH&STEAM → 205

TAUCH&STEAM → 205

TAUCH&STEAM → 205

TAUCH&STEAM → 205

TAUCH&STEAM → 205

TAUCH&STEAM → 205

持浴室内蒸汽的浓度以及有效降低能耗。

AQUASTEAM → 219

TAUCH&STEAM → 205

TAUCH&STEAM → 205

TAUCH&STEAM → 205

一块弧形折弯的玻璃触控面板，水流及水钵的配置使得Aquasteam系列蒸汽发生器更加实用且操作便捷，可与任意外饰面完美搭配。

特点
- 带流水系统的蒸汽发生器，水钵以及香氛疗法
- Effegibi技术研发的蒸汽发生器：严格控制蒸汽的质量、浓度及清洁度。

- 锅炉自动清洗功能可以降低维护频率并延长使用寿命。
- 设计优雅而紧凑，仅由一块丝网钢化玻璃面板制成，可见厚度仅为3.7cm。
- 触摸式控制面板，配置背光式图标以及温度指示器。
- 预留彩色光谱疗法系统选配连接口。
- 可以和Effegibi品牌的任意门板及玻璃面板进行搭配，尤其适用于专业土耳其浴室设计。

EASYSYSTEM → 227

TAUCH&STEAM → 205

TAUCH&STEAM → 205

TAUCH&STEAM → 205

TAUCH&STEAM → 205

TAUCH&STEAM → 205

TAUCH&STEAM → 205

TAUCH&STEAM → 205

TAUCH&STEAM → 205

TAUCH&STEAM → 205

TAUCH&STEAM → 205

TAUCH&STEAM → 205

TAUCH&STEAM → 205

TAUCH&STEAM → 205

TAUCH&STEAM → 205

TAUCH&STEAM → 205

TAUCH&STEAM → 205

TAUCH&STEAM → 205

TAUCH&STEAM → 205

连接口。
- 可以和Effegibi品牌的任意门板及玻璃面板进行搭配，尤其适用于专业土耳其浴室设计。

TAUCH&STEAM → 205

TAUCH&STEAM → 205

TAUCH&STEAM → 205

TAUCH&STEAM → 205

TAUCH&STEAM → 205

TAUCH&STEAM → 205

TAUCH&STEAM → 205

TAUCH&STEAM → 205

TAUCH&STEAM → 205

TAUCH&STEAM → 205

TAUCH&STEAM → 205

TAUCH&STEAM → 205

TAUCH&STEAM → 205

TAUCH&STEAM → 205

TAUCH&STEAM → 205

TAUCH&STEAM → 205

TAUCH&STEAM → 205

TAUCH&STEAM → 205

TAUCH&STEAM → 205

TAUCH&STEAM → 205

TAUCH&STEAM → 205

TAUCH&STEAM → 205

TAUCH&STEAM → 205

TAUCH&STEAM → 205

TAUCH&STEAM → 205

TAUCH&STEAM → 205

TAUCH&STEAM → 205

TAUCH&STEAM → 205

TAUCH&STEAM → 205

TAUCH&STEAM → 205

TAUCH&STEAM → 205

TAUCH&STEAM → 205

TAUCH&STEAM → 205

TAUCH&STEAM → 205

TAUCH&STEAM → 205

蒸汽扩散装置:
Nuvola Smart Power 配备了一款新型高科技蒸汽散发装置，其中包括送风功能，这样保持蒸汽的浓度与温度均匀分布。

Nuvola Smart Power系列的可用功率从2.5kw到36kw不等，适用的最大使用空间可达到50立方米。

如果需使用于更大的空间，可直接向Effegibi工厂进行咨询，研究可行的客户解决方案。

FEELGOOD → 249

NUVOLA SMART POWER → 235

TAUCH&STEAM → 205

TAUCH&STEAM → 205

TAUCH&STEAM → 205

TAUCH&STEAM → 205

TAUCH&STEAM → 205

TAUCH&STEAM → 205

TAUCH&STEAM → 205

TAUCH&STEAM → 205

TAUCH&STEAM → 205

TAUCH&STEAM → 205

TAUCH&STEAM → 205

TAUCH&STEAM → 205

TAUCH&STEAM → 205

TAUCH&STEAM → 205

TAUCH&STEAM → 205

TAUCH&STEAM → 205

TAUCH&STEAM → 205

TAUCH&STEAM → 205

TAUCH&STEAM → 205

TAUCH&STEAM → 205

TAUCH&STEAM → 205

TAUCH&STEAM → 205

TAUCH&STEAM → 205

TAUCH&STEAM → 205

TAUCH&STEAM → 205

TAUCH&STEAM → 205

TAUCH&STEAM → 205

– 提供两种款式: 门及蒸汽柱 ( 88x198 cm ), 或

门、蒸汽柱及固定玻璃板 ( 145x198 cm )。

- 带背光图标的触碰式控制面板, 控制所有的功能。

- 暖浴功能: 带预热功能的热风推送系统。

- 强力蒸汽功能: 利用送风系统, 减小温度分层, 使浴室内的温度均匀分布。

<b>STEAMBOX</b>	<b>→ 274</b>
-----------------	--------------

蒸汽箱
Steambox 蒸汽箱的设计充满着天赋性的创造, 实现了结构墙体的快速安装及与外部的完美隔离, 可以保证内部的最佳温度和蒸汽质量。整套蒸汽箱包含不同厚度的聚苯乙烯保温板 ( 5cm和10cm厚度 ), 其上附有织网并用水泥封层, 配置带铺设好排水管道的浴室地面, 以及具有倾斜角度的浴室屋顶。整套包装内包括箱体粘接及防水操作的必备材料。蒸汽箱的表面还可以用客户选定的瓷砖或马萨克进行装饰, 有多种组合方式, 也可以选择不同款式的蒸汽发生器, 以及专门研发的Spazio无框门板进行组合。

<b>ESS</b>	<b>→ 278</b>
------------	--------------

Effegibi声音系统
将Effegibi的音响装置与平板或智能手机连接, 就可以在土耳其浴室内或指定环境里, 聆听自己喜爱的音乐。通过预置在结构内的扬声器, 可以在土耳其浴室内欣赏音乐。此音响系统配置两个音箱, 可以和浴室内的扬声器自行匹配, 无需安装软件或进行特殊连接。

– 提供两种款式: 门及蒸汽柱 ( 88x198 cm ), 或

门、蒸汽柱及固定玻璃板 ( 145x198 cm )。

Effegibi 舒适控制系统
Effegibi 的每一款蒸汽发生器都配置了这个系统, 只需在平板或智能手机上下载 Effegibi应用软件, 就可以远程控制管理自己的土耳其浴室。在家中其他地方, 可以通过设置开启时间、温度、喜好的灯光, 设定自己最舒适的模式。另外, 如果土耳其浴室内覆盖无线wifi信号, 可以在任何位置进行远程设置 ( 办公室里、汽车里, 等等 )。最后, Effegibi的应用软件, 还可以提供给用户更多的产品使用信息: 从如何更好的使用土耳其浴, 到土耳其浴的功效, 以及介绍土耳其浴的历史及洗浴仪式。

<b>DOORS AND GLASS PANELS</b>	<b>→ 282</b>
-------------------------------	--------------

专用门和玻璃
Effegibi 特殊研发的蒸汽浴专用门, 可以完美地避免蒸汽外溢, 同时保证适量空气的正常循环。不锈钢材质边框以及8mm厚度的钢化玻璃, 不仅经久耐用, 更与各种装饰风格百搭。使用 Effegibi研发的专业蒸汽门, 还可以将家用淋浴空间, 通过简单改造, 升级成完美的土耳其浴空间。

<b>SEATING AND SPRINGS</b>	<b>→ 291</b>
----------------------------	--------------

#### 座椅 - 水池

土耳其浴室及淋浴空间内部专用的装饰配件, 使用易于清洁的材料制造, 在充满水汽的环境下依然耐用。

– 提供两种款式: 门及蒸汽柱 ( 88x198 cm ), 或

门、蒸汽柱及固定玻璃板 ( 145x198 cm )。

Effegibi 舒适控制系统
Effegibi 的每一款蒸汽发生器都配置了这个系统, 只需在平板或智能手机上下载 Effegibi应用软件, 就可以远程控制管理自己的土耳其浴室。在家中其他地方, 可以通过设置开启时间、温度、喜好的灯光, 设定自己最舒适的模式。另外, 如果土耳其浴室内覆盖无线wifi信号, 可以在任何位置进行远程设置 ( 办公室里、汽车里, 等等 )。最后, Effegibi的应用软件, 还可以提供给用户更多的产品使用信息: 从如何更好的使用土耳其浴, 到土耳其浴的功效, 以及介绍土耳其浴的历史及洗浴仪式。

<b>OTHER ACCESSORIES</b>	<b>→ 296</b>
--------------------------	--------------

<b>AROMATERAPHY</b>	<b>→ 301</b>
---------------------	--------------

<b>SEATING AND SPRINGS</b>	<b>→ 291</b>
----------------------------	--------------

<b>DOORS AND GLASS PANELS</b>	<b>→ 282</b>
-------------------------------	--------------

专用门和玻璃
Effegibi 特殊研发的蒸汽浴专用门, 可以完美地避免蒸汽外溢, 同时保证适量空气的正常循环。不锈钢材质边框以及8mm厚度的钢化玻璃, 不仅经久耐用, 更与各种装饰风格百搭。使用 Effegibi研发的专业蒸汽门, 还可以将家用淋浴空间, 通过简单改造, 升级成完美的土耳其浴空间。

<b>SEATING AND SPRINGS</b>	<b>→ 291</b>
----------------------------	--------------

#### 座椅 - 水池

土耳其浴室及淋浴空间内部专用的装饰配件, 使用易于清洁的材料制造, 在充满水汽的环境下依然耐用。

<b>OTHER ACCESSORIES</b>	<b>→ 296</b>
--------------------------	--------------

<b>AROMATERAPHY</b>	<b>→ 301</b>
---------------------	--------------

– 提供两种款式: 门及蒸汽柱 ( 88x198 cm ), 或

门、蒸汽柱及固定玻璃板 ( 145x198 cm )。

- 带背光图标的触碰式控制面板, 控制所有的功能。

- 暖浴功能: 带预热功能的热风推送系统。

- 强力蒸汽功能: 利用送风系统, 减小温度分层, 使浴室内的温度均匀分布。

<b>STEAMBOX</b>	<b>→ 274</b>
-----------------	--------------

蒸汽箱
Steambox 蒸汽箱的设计充满着天赋性的创造, 实现了结构墙体的快速安装及与外部的完美隔离, 可以保证内部的最佳温度和蒸汽质量。整套蒸汽箱包含不同厚度的聚苯乙烯保温板 ( 5cm和10cm厚度 ), 其上附有织网并用水泥封层, 配置带铺设好排水管道的浴室地面, 以及具有倾斜角度的浴室屋顶。整套包装内包括箱体粘接及防水操作的必备材料。蒸汽箱的表面还可以用客户选定的瓷砖或马萨克进行装饰, 有多种组合方式, 也可以选择不同款式的蒸汽发生器, 以及专门研发的Spazio无框门板进行组合。

<b>ESS</b>	<b>→ 278</b>
------------	--------------

Effegibi声音系统
将Effegibi的音响装置与平板或智能手机连接, 就可以在土耳其浴室内或指定环境里, 聆听自己喜爱的音乐。通过预置在结构内的扬声器, 可以在土耳其浴室内欣赏音乐。此音响系统配置两个音箱, 可以和浴室内的扬声器自行匹配, 无需安装软件或进行特殊连接。



# Steam generator features

	TOUCH&STEAM	EASYSTEAM	AQUASTEAM	NUVOLA SMART POWER	OMNIASTEAM
POWER STEAM FUNCTION Steam diffusion and forced ventilation heating system	✓			✓	✓
RWF - Regulating water flow Can work on a wide range of water system with different pressures	✓	✓	✓	✓	✓
SWF - Smart Water Filling Optimised management of boiler filling	✓	✓	✓	✓	✓
SBC - Smart Boiler Cleaning Dilution and intermediate rinsing processes not time controlled but based on real need	✓	✓	✓	✓	✓
SEC - Smart Energy Control Evenly spaced on/off periods for the heating elements	✓	✓	✓	✓	✓
ODS - Open Door Sensor				✓	✓
Steam diffuser with adjustable flaps to control the outgoing steam direction				✓	
Additional temperature probe				✓	
ECC - Effegibi Comfort Control The turkish bath can be remotely controlled from your tablet or smartphone	✓	✓	✓	✓	✓
ESS - Effegibi Sound System The sound is transmitted inside the Hammam by the Effegibi Docking Station	✓				
Container for essential oils	✓	✓	✓	✓	✓
Steam output led light	✓	✓	✓	✓	
Touch-screen control panel with backlit icons and temperature gauge	✓	✓	✓	✓	✓
Lighting system with led RGB colour therapy	✓				✓
CALDO DOCCIA FUNCTION Unit pre-heating function with forced ventilation heating system	✓				✓
Waterfall spring with controlled backlit water flow			✓		



**Thanks to:**

Lea Ceramiche  
 Ceramiche Mutina  
 Ceramica Sant'Agostino  
 Fratelli Fantini  
 Falper  
 Spencer Contract

**Special thanks to:**

Relais & Châteaux Rosa Alpina, San Cassiano  
 La Casa del Porto, Lovere  
 Tenuta Le Cave, Tregnago  
 Excelsior Hotel Gallia, Milan

**Art direction & graphic design:**

Zup

**Printing:**

OGM, Padova

**Photo:**

Simone Casetta

Andrea Martiradonna

P. 90-91

Mauro Motty

P. 58-59, 60-61

Giorgio Salvadori

P. 64-65, 66-67, 164-165, 266-267

Michele Tortoioli

P. 174-175, 181, 183

Max Zambelli

P. 177, 180

**33 Multimedia Studio**

P. 55, 93, 95, 97, 111, 114-115, 116, 117,  
 146, 149, 150-151, 271, 272-273, 289, 297

**Effegibi archives**

P. 88-89, 131, 166-167, 264-265

The images and data contained in this catalogue are merely a guide and may be changed at any time without notice.

Effegibi: all rights reserved  
 Total or partial reproduction of the text or illustrations in this catalogue is prohibited and subject to legal sanctions.

Le immagini e i dati contenuti nel presente catalogo sono da ritenersi indicativi e possono subire variazioni anche senza alcun preavviso.

Effegibi: tutti i diritti riservati  
 Ogni riproduzione totale o parziale dei contenuti del presente catalogo, sia di testo che di immagine, è vietata e sarà perseguita a termini di legge.

**effegibi®**  
 PERFECT WELLNESS

**effegibi®**

Via Gallo 769  
47522 Cesena (FC)  
Italy

tel. +39 0547 372881  
fax +39 0547 372924

[www.effegibi.it](http://www.effegibi.it)  
[info@effegibi.it](mailto:info@effegibi.it)